



**OPERATING AND  
INSTRUCTION MANUAL**

MODELS

*Signature<sup>®</sup>*  
*Signature & Signature<sup>2</sup>*

**Safeline** + PLUS +  
P•O•W•E•R•P•H•A•S•E +

Supplied by:

**SAFELINE LTD**  
**MONTFORD ST, SALFORD, ENGLAND**  
Tel: 44 (0)161 848 8636  
Fax: 44 (0)161 888 2292

Copyright © Safeline limited, 1996, 1997 2000

No part of this document may be reproduced, or translated, in any form, electronic or otherwise without the prior written consent of Safeline limited.

Neither Safeline nor its Agents will be liable for incidental or consequential damage in connection with the use of this document.

Safeline reserve the right to change the contents or form of this manual at any time without prior notice having been given.

This detector must only be used for the express purposes as advertised by Safeline and as referred to in this and other Safeline approved literature.

## **Aims of this manual.**

This manual is intended to help those customers who need to:

- 1) Install the detector
- 2) Commission the detector subsequent to replacement or installation.
- 3) Operate the detector on a day to day basis.
- 4) Change some of the product dependent and installation dependent parameters.
- 5) Communicate with the detector using serial communications.
- 6) Arrange a maintenance schedule using the printer option.

This manual is NOT intended as either-

- 1) A Service Manual, (although some fundamental diagnosis is included in this manual).
- 2) A Workshop Manual - No detailed technical analysis, either mechanical, electrical or electronic is contained in this manual.
- 3) Commercial information - for example sales literature or publicity information.

Safeline technical publications are designed to be backwardly compatible with all previous versions of detectors in the family. This means that the later issues of manuals will be fully compatible with older equipment, however the older equipment may not have all of the features of later manuals.

## **NOTE.**

An upgrade service is available from Safeline, at a fee, that will upgrade older detectors to the latest specification, where possible. Please contact your supplier's technical departments for information on this service. Remember to have your serial number ready when making the call.

# PRELIMINARY PAGES

## Amendments

Safeline have a policy of updating manuals to include new features, correct erratum, or incorporate customers requests. The Amendment Record below is provided for the express purpose of the customer, or supplier, to record any amendments that may have been included in this document.

For further information or to order copies of this document contact Safeline Ltd. at the address shown on the title page of this document, quoting the reference number given on the title page.

If the document was purchased directly from Safeline, or the supplier is unavailable at the supplier address given, then contact Safeline directly via the address given on the title page of this document.

If the owner of the manual has any comments or suggestions as to the form, content or presentation of this manual then they should write their suggestions and send them to the Technical Department at the Safeline address given on the title page.

### Amendment Record

If you receive an update for this manual then:

1. Attach the update sheet(s) to the rear of the manual.
2. In the row whose 'Amendment' number matches that of the received amendment:-
  - a) Print your name in the 'Incorporated By' box.
  - b) Print the 'Date' box with the date you updated the manual.

| <b>AMENDMENT</b> | <b>INCORPORATED BY</b> | <b>DATE</b>    |
|------------------|------------------------|----------------|
| 1. Issue 1       | Safeline               | January 1997   |
| 2. Issue 2       | Safeline               | September 1997 |
| 3. Issue 3       | Safeline               | January 2000   |
| 4. Issue 4       | Safeline               | October 2002   |
| 5. Issue 5       | Safeline               | December 2002  |
| 6. Issue 6       | Safeline               | March 2003     |
| 7. Issue 7       | Safeline               | July 2003      |
| 8. Issue 8       | Safeline               | July 2003      |
| 9.               |                        |                |
| 10.              |                        |                |
| 11.              |                        |                |
| 12.              |                        |                |
| 13.              |                        |                |
| 14.              |                        |                |
| 15.              |                        |                |
| 16.              |                        |                |
| 17.              |                        |                |
| 18.              |                        |                |
| 19.              |                        |                |
| 20.              |                        |                |
| 21.              |                        |                |
| 22.              |                        |                |
|                  |                        |                |

## Warnings and Cautions



**THE ABOVE CAPTION IDENTIFIES AN OPERATING PROCEDURE OR PRACTICE THAT COULD RESULT IN PERSONAL INJURY OR DEATH.**



**The above caption identifies an operating procedure or practice that could result in damage, or destruction, of the detector, the process or its surroundings.**



**The above caption is used to draw the readers attention to a note of extra importance.**

---



**This manual is regarded as an integral part of the detector.  
This manual must always be kept with the detector for the whole of its operating life.**

---



**WHEN THIS CAPTION IS SHOWN ON THE EQUIPMENT IT IS USED TO INDICATE THE POSSIBILITY OF ELECTRIC SHOCK.**



**WHEN THIS CAPTION IS SHOWN ON THE EQUIPMENT IT IS USED TO INDICATE THAT THE MANUAL MUST BE CONSULTED BEFORE PROCEEDING.**

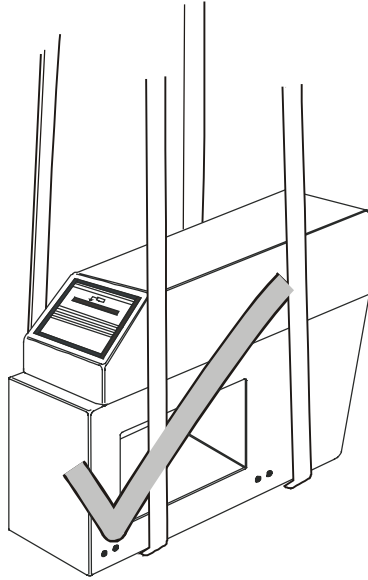
# PRELIMINARY PAGES

## Handling instructions

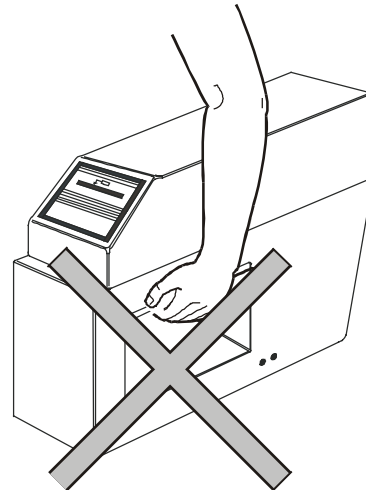
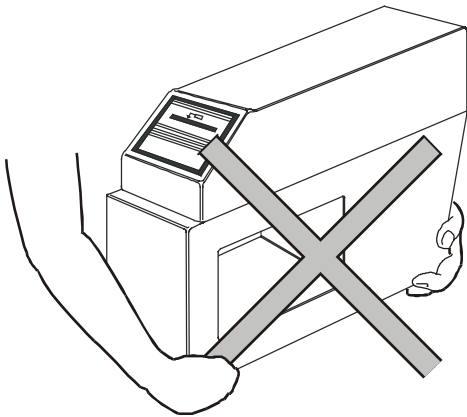
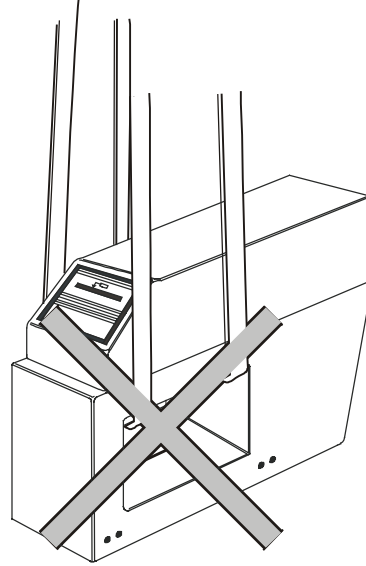
The detector does not contain any exposed noxious or dangerous substances.

When transporting and handling the detector damage may result if the lifting equipment (i.e. sling, cable assembly or by hand) passes through the aperture of the detector. The diagrams below show the incorrect way and the correct way to lift and support the detector during transportation.

**CORRECT**



**INCORRECT**



Safeline does not recommend the lifting or supporting of the detector by a person. Always use suitable lifting or supporting apparatus. Safeline will accept no liability for personal injury caused by attempting to lift or move the detector without the aid of a mechanical apparatus.

If supporting the detector in a sling or other lifting apparatus always ensure that the detector is securely held and is not likely to unbalance during lifting.

## Safety Instructions

Most companies have a code of practice for their employees which is designed to ensure their safety in the working environment. When new equipment is introduced it is important that operators, maintenance engineers and supervisors are aware of the potential hazards.

The following guidelines must be followed by any person concerned with the operation, installation or handling of the detector to ensure correct operation and to avoid any damage to the detector or to the person concerned.



**The equipment should only be used in accordance with the instructions given herein. Failure to comply with these instructions may lead to the protection provided by the equipment becoming impaired. Safeline will not be liable for incidental or consequential damage if the equipment is not installed in accordance with the instructions given.**



**On no account should any of the electrical panels of your detector be opened by anyone other than a qualified electrical engineer. Voltages in excess of 30 volts rms or 50 volts DC. can, in certain circumstances be lethal. When working on electrical or electronic equipment always follow current health and safety practices and observe all other applicable regulations.**



**For correct operation and to prevent any damage to the detector follow the instructions given in this document under the heading 'Installation'.**



In accordance with EN 61010-1:1993 this equipment has been designed to be safe at least under the following conditions:

Indoor use.

Altitude up to 2000m.

Storage temperature: -10 °C to +50 °C (15 °F to 120 °F)

Operating temperature: -10 °C to +40 °C (15 °F to 110 °F)

Maximum relative humidity 93% for temperatures up to 45°C.

For connection to TN (EN60950:1992) power distribution systems only, for connections to other power distribution systems please contact your supplier.

Mains supply voltage fluctuations not to exceed +10%/-15% of the nominal voltage.

Transient overvoltages according to INSTALLATION CATEGORY III.

Pollution degree 2 in accordance with IEC 664.

## Detector Precautions



CAUTION

During installation and operation of the detector the following points must be considered. Failure to do so may result in difficulties of operation, degradation in the performance or damage occurring to your detector.

### 1. Electric Arc Welding

Electric Arc Welding must not be carried out on the detector or on any part of the attached conveyor system. If Electric Arc Welding must be carried out on any attached systems, disconnect and remove the detector head and detector power supply box prior to welding.

### 2. Power Source

It is recommended that the power source should be taken from a source which supplies only low power equipment.

It is recommended that the detector should not be connected to power sources which are supplying varying current loads, e.g. Invertors, variable-speed drives etc.

It is recommended that the power source for the detector should be connected via an independent spur.

The power source for the detector should be fitted with an isolation switch and the appropriate circuit breaker and/or fuse.

### 3. Electromagnetic Interference

It is recommended that the detector should not be installed in close proximity to any devices which may emit electromagnetic interference e.g. Radio transmitters.

Ensure all Invertors and variable-speed drives in the proximity of the detector are installed in full accordance with their manufacturers instructions.

Where possible avoid placing any cables from Invertors, variable-speed drives etc. in close proximity to the detector or the detector cables.

In particular take care to avoid placing the detector in the proximity of any equipment that generates electromagnetic interference in the same frequency range as the detector.

### 4. Magnetic Fields (Ferrous Detectors Only)

It is recommended that this type of detector should not be installed in close proximity to any potential source of magnetic fields.

### 5. Metal Free Zone (M.F.Z.)

To achieve the optimum detector performance, an area surrounding the aperture of the detector known as the Metal Free Zone (M.F.Z.) must be kept free of metal.

The size of this zone will be dependant upon the type of detector, the detector's aperture height and the detector's operating sensitivity.

Stationary metal may be positioned closer to the detector than moving metal.

Typical values of M.F.Z for standard metal detectors are:

M.F.Z. = 1.5 x aperture-height for stationary metal

M.F.Z. = 2.0 x aperture-height for moving metal.

Typical values of M.F.Z for Ferrous detectors are:

M.F.Z. = 1.5 x aperture-height for stationary non-Ferrous metal

M.F.Z. = 2.0 x aperture-height for moving non-Ferrous metal.

M.F.Z. = 2.0 x aperture-height for stationary Ferrous metal

M.F.Z. = 3.0 x aperture-height for moving Ferrous metal.

## 6. **Avoiding aperture damage**

At all times ensure that the product does not come in contact with, or impact onto the detector aperture or aperture lining.

## 7. **Handling and lifting**

When transporting and handling the detector damage may result if the lifting equipment (e.g. sling, cable assembly or by hand) passes through the aperture of the detector.

Never pass any lifting or supporting equipment through the detector aperture.

Always observe best practices for handling heavy items when lifting or moving the detector.

## 8. **Detector support structures**

Avoid supporting the detector on vibrating structures and/or machines subject to mechanical shock.

No part of the supporting structure should rely on the detector for structural integrity.

No part of the supporting structure should be attached to the detector other than through the detector mounting blocks supplied.

## 9. **Belt maintenance**

Certain substances (e.g. metal fragments, liquids etc.) which can be detected by the metal detector are likely to cause unexpected detections (often giving the appearance of erratic/incorrect operation) if they adhere to the conveyor belt.

To minimise the chance of this occurring:

- a) Avoid any operations that may cause metal fragments to come into contact with the conveyor belt e.g. welding, metal drilling or cutting in the vicinity of the conveyor belt.
- b) Clean the conveyor belt regularly.

## 10. **Orientation of contaminants**

Metal detector sensitivity is expressed as the diameter of the smallest spherical object which can be detected. (i.e. diameter of a ball).

Sensitivity to non-spherical objects of the same material (e.g. wire fragments) will vary according to the orientation of the object as it passes through the detector aperture. If the diameter of the object is less than the stated spherical sensitivity the object may not be detected.

## 11. **Product packaging materials**

To achieve the optimum detector performance in applications where the product being inspected is packaged - ensure that the packaging materials used are free from metal contamination.

## 12. **Continuous maintenance and testing**

It is recommended that at regular intervals testing with an appropriate test sample is performed to ensure the detector and any attached reject mechanism is functioning correctly.

It is recommended that inspection and cleaning of the detector system should be carried out at regular intervals.

## 13. **Static Precautions.**

Where a metal detector is to be fitted on a conveyor or otherwise it necessary to bond the metal work to ground.



# PRELIMINARY PAGES

## Contents

### PRELIMINARY PAGES

|                             |      |
|-----------------------------|------|
| Aims of this manual .....   | ii   |
| Amendments.....             | iii  |
| Warnings and Cautions ..... | iv   |
| Handling instructions ..... | v    |
| Detector Precautions .....  | vii  |
| INDEX .....                 | xiii |

### LIST OF ILLUSTRATIONS ..... XIV

|  |   |
|--|---|
| Features of your Metal Detector .....            | 3 |
| Product Numbers.....                             | 3 |
| Timer Groups .....                               | 3 |
| Timer Types .....                                | 3 |
| Product Signal Cancellation (PSC) (option) ..... | 3 |
| Automatic Tracking (option).....                 | 3 |
| Inverse Detection.....                           | 3 |

### QUALITY ASSURANCE SUPPORT (OPTION)..... 4

### TECHNICAL SPECIFICATION ..... 5

|   |   |
|---|---|
| Technology .....                              | 5 |
| Frequency of Operation of Coil.....           | 5 |
| Product throughput speed .....                | 5 |
| Power Input.....                              | 5 |
| Internal Battery.....                         | 5 |
| Environmental Protection.....                 | 5 |
| Switched Power Output .....                   | 5 |
| Reject Relay.....                             | 5 |
| Detect Signal.....                            | 6 |
| Q.A. Due/Overdue Output .....                 | 6 |
| Pack Sensor Requirements .....                | 6 |
| Speed Sensor Requirements.....                | 6 |
| Reject Confirmation Sensor Requirements ..... | 6 |
| RS232 Serial Communications.....              | 6 |
| Internal Counters .....                       | 7 |
| Spherical Sensitivity.....                    | 7 |
| Sensitivity Gradient.....                     | 7 |
| Timer Ranges .....                            | 7 |

### GENERAL..... 8

### MECHANICAL INSTALLATION ..... 8

|  |                                     |
|--|-------------------------------------|
| Metal Free Zone (MFZ).....                     | 8                                   |
| Figure 4 Metal Free Zone Guidelines .....      | <b>Error! Bookmark not defined.</b> |
| Construction of the Detector Installation..... | 9                                   |
| Positioning the Detector Head .....            | 9                                   |
| Electrical Connections .....                   | 9                                   |

### ELECTRICAL INSTALLATION..... 12

|  |    |
|--|----|
| General .....                                      | 12 |
| Location and Layout of the Detector Terminals..... | 12 |
| Removing the Power Supply Box Lid .....            | 12 |

### INTRODUCTION ..... 16

|                                |    |
|--------------------------------|----|
| The Touch Keys Explained.....  | 17 |
| Changing Numeric Values .....  | 19 |
| Universal Settings Guide ..... | 21 |

### RUNNING MODE ..... 32

# PRELIMINARY PAGES

|  |           |
|--|-----------|
| Introduction .....                                     | 32        |
| Pack Count and Reject Count .....                      | 33        |
| Time .....   | 33        |
| <b>OPERATOR MODE .....</b>                             | <b>35</b> |
| Introduction .....                                     | 35        |
| Product Number, Auto Setup and Name .....              | 35        |
| Sensitivity and Phase .....                            | 35        |
| <b>SUPERVISOR MODE .....</b>                           | <b>37</b> |
| Introduction .....                                     | 37        |
| Product Number, Auto Setup and Name .....              | 37        |
| Sensitivity and Phase .....                            | 37        |
| Operating Frequency .....                              | 38        |
| Select Timer Group .....                               | 38        |
| Reject Count .....                                     | 38        |
| Pack Count .....                                       | 38        |
| <b>ENGINEER MODE .....</b>                             | <b>40</b> |
| Introduction .....                                     | 40        |
| Product Number, Auto Setup and Name .....              | 40        |
| Sensitivity and Phase .....                            | 40        |
| Operating Frequency .....                              | 41        |
| Power Drive .....                                      | 41        |
| Select and Update Timer .....                          | 42        |
| Inverse Detection .....                                | 42        |
| Automatic Tracking (option) .....                      | 43        |
| Reject Count .....                                     | 43        |
| Pack Count .....                                       | 43        |
| Pack Sensor Setup .....                                | 44        |
| Security Setup .....                                   | 44        |
| Speed setup .....                                      | 45        |
| Auto. tracking setup .....                             | 45        |
| Detection Buzzer .....                                 | 45        |
| Reject inhibit (Versions XT1.00 and XT1.01 only) ..... | 45        |
| Boost Mode .....                                       | 46        |
| Language .....   | 46        |
| Set Date and Time (Option) .....                       | 47        |
| Printer Handshake (Option) .....                       | 47        |
| <b>AUTOMATIC SETUP .....</b>                           | <b>48</b> |
| Introduction .....                                     | 48        |
| Product Signal Cancellation .....                      | 50        |
| <b>VIBRATION SETUP .....</b>                           | <b>54</b> |
| Introduction .....                                     | 54        |
| NOTE .....   | 54        |
| Sensitivity limit .....                                | 54        |
| <b>PACK SENSOR SETUP .....</b>                         | <b>56</b> |
| Introduction .....                                     | 56        |
| Gating .....   | 56        |
| Pack Sensor Fitted .....                               | 56        |
| Sensor distance .....                                  | 56        |
| Pack Sensor Calibration .....                          | 57        |
| <b>SECURITY SETUP .....</b>                            | <b>59</b> |
| Introduction .....                                     | 59        |
| <b>SPEED SETUP .....</b>                               | <b>62</b> |
| Introduction .....                                     | 62        |
| Speed range .....                                      | 62        |
| Automatic tracking maximum rate .....                  | 64        |

# PRELIMINARY PAGES

|   |            |
|---|------------|
| <b>QA INSPECTOR MODE (OPTION)</b> .....                                     | <b>67</b>  |
| Introduction .....  | 67         |
| Printer .....   | 67         |
| Configuring the Performance Validation Routine .....                        | 68         |
| Line Identification .....   | 68         |
| Printer Fitted .....  | 68         |
| Printer Fixed/Portable .....  | 68         |
| Test Samples .....  | 69         |
| Shift Report Options .....  | 69         |
| Shift Report Interval .....   | 70         |
| Shift Report Start Time .....   | 70         |
| Test Interval .....   | 71         |
| Overdue Period .....  | 71         |
| Alarm If Overdue .....  | 72         |
| Change QA Operator Code .....   | 72         |
| <b>QA OPERATOR MODE</b> .....   | <b>74</b>  |
| Introduction .....  | 74         |
| QA Operator Security Codes .....  | 74         |
| Carrying Out a Performance Check .....                                      | 74         |
| Notes on the Test Sample .....  | 74         |
| Select Test Material .....  | 74         |
| <b>VIEWING MODE</b> .....   | <b>77</b>  |
| Introduction .....  | 77         |
| <b>REJECT TIMERS INTRODUCTION</b> .....                                     | <b>78</b>  |
| Recommended Applications .....  | 78         |
| Timer Groups A, B or C .....  | 78         |
| Sample size selection .....   | 78         |
| <b>tm1 TIMER</b> .....  | <b>81</b>  |
| <b>tm2[G] TIMER - NON GATED MODE</b> .....                                  | <b>84</b>  |
| Introduction .....  | 84         |
| tm2 settings .....  | 84         |
| <b>tm2G TIMER - GATED MODE</b> .....  | <b>88</b>  |
| <b>tm3[G] TIMER - NON GATED MODE</b> .....                                  | <b>94</b>  |
| Setting up Timer Type tm3 .....   | 94         |
| <b>tm3[G] TIMER - GATED MODE</b> .....                                      | <b>99</b>  |
| Setting up timer type tm3G in gated mode .....                              | 100        |
| <b>SPEED SENSOR FOR THE TM3 AND TM3[G] TIMERS</b> .....                     | <b>109</b> |
| Speed Sensor Requirements .....   | 109        |
| Speed Sensor Electrical Connections .....                                   | 109        |
| Producing A Rotary Encoder Using A Proximity or Photo-electric Sensor ..... | 109        |
| Disc Construction .....   | 110        |
| Determining The Required Shift Distance Of The Speed Sensor .....           | 110        |
| <b>SETTING UP AND CONNECTING A PRINTER TO THE METAL DETECTOR</b> .....      | <b>112</b> |
| General .....   | 112        |
| Requirements Of Your Serial Printer .....                                   | 112        |
| Connection of Printer to Detector .....                                     | 113        |
| <b>SAMPLE PRINTED REPORTS</b> .....   | <b>114</b> |
| <b>METAL DETECTOR SERIAL COMMUNICATIONS LINK</b> .....                      | <b>118</b> |
| Introduction .....  | 118        |
| Host computer or intelligent equipment .....                                | 118        |

# PRELIMINARY PAGES

|  |            |
|--|------------|
| Specification of the serial link .....                 | 118        |
| Physical layer specification (OSI layer 1) .....       | 118        |
| Data-link layer specification (OSI layer 2).....       | 118        |
| Valid message identifiers .....                        | 120        |
| Commands the host can transmit.....                    | 128        |
| Commands the metal detector may transmit.....          | 128        |
| Command Identifier - 'E' Error Codes.....              | 130        |
| Command Identifier - 'Q' QA Lists and Displays.....    | 132        |
| QA Operator commands.....                              | 132        |
| QA Inspector commands .....                            | 132        |
| <b>EMULATION MODE .....</b>                            | <b>136</b> |
| Objective .....  | 136        |
| Principal of operation .....                           | 136        |
| <b>CRC GENERATION .....</b>                            | <b>142</b> |
| Method .....   | 142        |
| C Program.....   | 143        |
| <b>TIMING DIAGRAMS FOR SERIAL COMMUNICATIONS .....</b> | <b>144</b> |
| <b>MAGNETIC LOOPS .....</b>                            | <b>147</b> |
| <b>RECOMMENDATIONS FOR THE USE OF INVERTERS .....</b>  | <b>150</b> |
| <b>ATEX DIRECTIVE .....</b>                            | <b>151</b> |
| ATEX system label.....                                 | 152        |
| ATEX Static warning label .....                        | 152        |
| ATEX Enclosure warning label .....                     | 152        |

## INDEX

**A**

Amendments, iii  
 Aperture height, 9  
 Automatic setup, 3, 37, 39, 43, 52  
 Automatic tracking, 3, 46, 48, 68

**B**

Battery, 5  
 Bearing blocks, 12  
 Belt joint, 12  
 Boost mode, 49  
 Buzzer, 48

**C**

Cable Gland Assemblies, 16  
 Cautions, iv  
 Communications, 4, 6, 125  
 Conclamp, 15  
 Contents, vii  
 Control Panel, 17  
 Conveyor, 11  
 Counters, 6, 7  
 CRC generation, 143

**D**

Date, setting, 50  
 Detect signal, 6  
 Detector heads positioning, 10  
 Detector terminals, 13  
 Due alarm, 6, 76

**E**

Electrical connections, 10  
 Engineer Mode, 42  
 Environmental protection, 5

**F**

Fault output, 6.

**G**

Gated timers, 3, 83  
 Guides, 21

**H**

Handling instructions, v  
 How to ..., 21, 25, 26, 27

**I**

Installation, 9  
 Inverse detection, 3, 45

**L**

Language, 49  
 LCD, 17  
 Line identification, 72

**M**

Manually Setting the Detector, 28  
 Magnetic loops, 149  
 Metal free zone, 9

**N**

Name, 37, 39, 43  
 Next QA test, 34  
 Numeric Values, 20

**O**

Operator Access, 63  
 Operator mode, 37  
 Operating Frequency, 40, 44  
 Overdue  
   alarm at, 6, 76  
   output, 6  
   period, 75

**P**

Pack counter, 7, 34, 40, 46  
 Pack sensor  
   Calibration, 60  
   distance, 59  
   requirements, 6  
   setup, 47, 59  
 Page Display System, 18  
 Performance check, 25, 78  
 Performance Validation Guide, 25

**Phase**

control, 1  
 setting, 28, 37, 39, 43

Position of the detector, 10

Power drive, 43.

**Power supply**

connections, 14  
 specification, 5

**Printer**

setup, 72  
 handshake, 50  
 connections, 119  
 specification, 119

Printouts, 26, 77

samples, 121

Product effect, 1

Product name, 37, 39, 42

Product number

introduction, 3  
 setting, 37, 39, 42  
 setting guide, 24

Product signal cancellation, 3, 46, 53

Product speed, 27, 47, 66

Product Throughput Speed, 5

P.V.R., 4

**Q**

Q.A. Inspector Mode, 71

Q.A. Due/ Overdue, 6, 34

Q.A. Operator

mode, 78  
 security codes, 76, 78

Q.A. Support, 4

Q.A. test time, 34

**R**

RC sensor, 110

RCU Settings, 49, 110

Reject counter, 6

reading, 32, 40, 46  
 resetting, 40, 46

Reject confirmation, 49, 110

Reject confirmation unit, 110

Reject inhibit, 47, 48

Reject relay, 5

Reject timers, 82

Running mode, 33

**S**

Security, 19, 47, 63

Sensitivity

gradient, 7  
 limit, 57  
 spherical, 7

Sensitivity

setting, 37, 39, 43

Serial number, 33

Shifts, (Q.A.)

printouts, 71, 76, 77  
 report interval, 74  
 report options, 73  
 report start time, 74

Shift distance, 99, 104, 116

Soft keys, 18

Speed Change Guide, 27

Speed sensor connections, 6, 14

Speed sensor disk construction, 115

Speed sensor requirements, 6, 115

Speed setup, 66

Supervisor Mode, 39

Switched Power Output, 5

System Fault Relay, 5

**T**

Technical specification, 5

Temperature

operating, 5  
 storage, vi

Test interval, 71, 75

Test sample calibration, 73

Time

display, 34  
 setting, 50

Timers

groups, 3, 40, 45, 82  
 group selection, 40, 45, 82  
 introduction, 3, 82  
 ranges, 7  
 tm1 setting, 85  
 tm2, setting, 89  
 tm2G, setting, 93  
 tm3 setting, 99  
 tm3G setting, 104  
 types, 3

Touch Keys, 18

**U**

Universal Settings Guide, 22

**V**

Vibration setup, 47, 57

Vibration signals, 1

Viewing Mode, 81

**W**

Warnings, iv.

Warm up time, 5

## LIST OF ILLUSTRATIONS

| Figure   | Page |
|--|------|
| Fig 1 Phase/Amplitude .....  | 2    |
| Fig 2 Effect of Phase Control .....  | 2    |
| Fig 3 Effects of Unwanted Signals .....  | 2    |
| Fig 4 Metal Free Zone Guidelines .....   | 8    |
| Fig 5 Typical Metal Detector Conveyor .....  | 10   |
| Fig 6 Bearing Block And Mounting Foot Insulation .....                                 | 11   |
| Fig 7 Belt Joints .....  | 11   |
| Fig 8 Layout of components and Terminals .....   | 13   |
| Fig 9 Power Connections to the Detector .....  | 14   |
| Fig 10 Cable Gland Assemblies for Power Supply Unit .....                              | 15   |
| Fig 11 Control Panel .....   | 16   |
| Fig 12 Running Mode Flow Chart .....   | 31   |
| Fig 13 Operator Mode Flow Chart .....  | 34   |
| Fig 14 Supervisor Mode Flow Chart .....  | 36   |
| Fig 15 Engineer Mode Flow Chart .....  | 39   |
| Fig 16 Pack Sensor Mode Flow Chart .....   | 55   |
| Fig 17 Security Setup Flow Chart .....   | 58   |
| Fig 18 QA Inspector And Operator Flow Chart .....                                      | 66   |
| Fig 19 Viewing Mode Flow Chart .....   | 76   |
| Fig 20 Viewing Mode Flow Chart cont. ....  | 77   |
| Fig 21 Tm1 Timer Flow Chart .....  | 80   |
| Fig 22 Tm2 Timer Flow Chart .....  | 83   |
| Fig 23 Tm3 Timer Flow Chart .....  | 93   |
| Fig 24 Rotary Encoder .....  | 109  |
| Fig 25 Disc Construction .....   | 110  |
| Fig 26 Determining The Required Shift Distance .....                                   | 110  |
| Fig 27 D-1 Host Query of Detector .....  | 144  |
| Fig 28 D-2 Host Command type 1, (causes change in value of detector variable) .....    | 144  |
| Fig 29 D-3 Host Command type 2, (causes NO change in value of detector variable) ..... | 144  |
| Fig 30 D-4 Event Occurrence inside detector .....                                      | 145  |
| Fig 31 Event driven message interrupting normal ack/nak response to the host .....     | 146  |

## LIST OF ABBREVIATIONS

|                    |   |
|--------------------|---|
| A                  | Ampere  |
| AC                 | Alternating current                             |
| AH                 | Aperture height                                 |
| CRC                | Cyclic redundancy check                         |
| D.C.               | Direct current                                  |
| Fe                 | Ferrous   |
| ft                 | foot  |
| Hz                 | Hertz   |
| k                  | Kilo ( $10^3$ )                                 |
| kHz                | KiloHertz                                       |
| kV                 | Kilovolt  |
| k $\Omega$         | KiloOhm   |
| LCD                | Liquid crystal display                          |
| LED, led           | Light emitting diode                            |
| m                  | metre   |
| mA                 | milliampere                                     |
| MFZ                | Metal free zone                                 |
| MHz                | MegaHertz                                       |
| min                | minute  |
| mm                 | millimetre                                      |
| ms                 | millisecond                                     |
| non-Fe             | Non-ferrous                                     |
| NPN                | Negative-positive-negative (type of transistor) |
| PNP                | Positive-negative-positive (type of transistor) |
| PSC                | Product signal cancellation                     |
| PVR                | Performance validation routines                 |
| QA                 | Quality assurance                               |
| RMS                | Root Mean Square                                |
| V                  | Volt  |
| VA                 | Volt amps                                       |
| W                  | Watt  |
| $^{\circ}\text{C}$ | Degree Celsius                                  |
| $^{\circ}\text{F}$ | Degree Fahrenheit                               |





# Principles of Operation for the Metal Detector

Safeline detectors utilise a low power, high frequency, magnetic field coil system which has the ability to sense minute disturbances created by metal particles. A metal particle passing through the aperture of the detector will create changes in the magnetic field inside the detector.

The changes in the magnetic field will generate electrical signals in the coil system which can be characterised by the parameters Phase and Amplitude.

The amplitude/size of the signal is related to the size of the metal particle passing through the field, the larger the metal particle the greater the amplitude of the signal.

Different types of metal generate signals which differ in phase angle. The term phase angle is a comparative term and is a measurement of phase relationship relative to some reference

## Vibration Signals

Great care is taken in the design and manufacture of the Safeline detectors to minimise the effect of vibration on the performance of the detectors. However mechanical disturbances do create vibration signals from the coil system.

Vibration signals can be represented in the same way as signals generated by metal particles i.e. a signal with amplitude and phase.

The vibration signal is used as a reference when comparing the phase angle of signals from the coil system. For example, if we say stainless steel has a particular value of phase angle, the phase angle is the angle relative to vibration. Reasons for selecting vibration as the reference phase will become apparent.

## Product Effect

Metal detectors are used to inspect all types of products e.g. food pharmaceuticals, plastics, chemicals and many others.

Some products exhibit a 'product effect' i.e. the product itself generates a signal in the same way as a metal particle. This results from the bulk conductivity of the product at high frequency.

For most products, usually dry products, the product effect is negligible. Wet or moist products, e.g. meat, sauces, soups etc. generate a large product effect signal which will influence the effective operating sensitivity of the detector.

Product effect signals can be represented diagrammatically as a signal with amplitude and phase in the same manner as the signals from metallic particles.

## Phase Control

The Safeline metal detector contains a phase control circuit which discriminates between the wanted signals from metal particles and the unwanted signals from vibration and product effect, i.e. it maximises the detectors response to metal particles whilst minimising the effects of the unwanted signals.

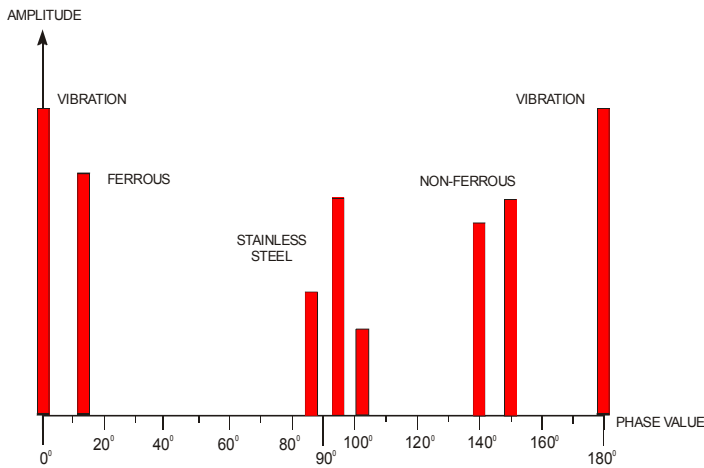
Probably the simplest way of reducing the vibration or product effect signals would be to adjust the sensitivity control. However, the sensitivity control would reduce the sensitivity to all signals, metallic signals, vibration and product signals alike.

What is required is a more selective adjustment that will discriminate between different signals. The phase control does this, it selectively reduces the signals from vibration and product effect with minimal effect on the metallic signals.

A comparison can be made with a domestic Hi-Fi system. The volume control of the Hi-Fi increases or decreases the amplitude of all signals just like the metal detector sensitivity control. The bass control of the Hi-Fi selectively controls the low frequency notes only. This is similar to the phase control circuit, however the phase control circuit in a Safeline metal detector is very much more selective.

Signals from the detector coil system can be represented as shown in Fig 1

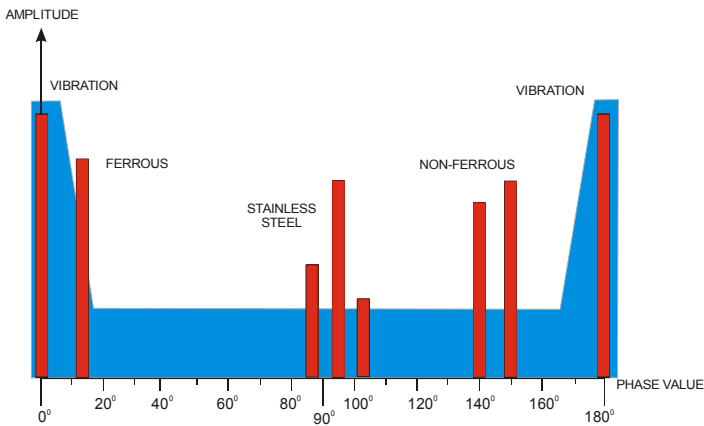
# PRINCIPLES OF OPERATION



**Fig 1 Phase/Amplitude**

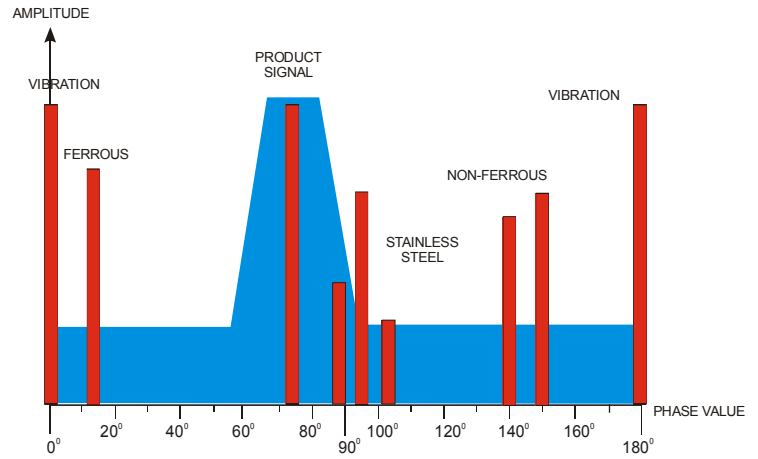
The characteristic of the phase control circuit is as shown in Fig 2. This shows the position of the phase control aligned to minimise the unwanted vibration signal. All signals which break through the phase control characteristic (the shaded area) will trigger the detector. From this it can be seen that the amplitude of the unwanted vibration signal would have to be increased to trigger the detector.

It can be seen from Fig 2 that the phase control characteristic masks off some of the ferrous signal and has a minimal effect on the Non Ferrous/Stainless Steel signals



**Fig 2 Effect of Phase Control**

The phase control is used to minimise unwanted product effect signals. Fig 3 shows a typical example. It can be seen from Fig 3 that the phase control characteristic masks off some of the Stainless Steel signals and has a minimal effect on the Ferrous signal. The detectors phase setting may be adjusted to align the phase control over any unwanted product effect signal.



**Fig 3 Effects of Unwanted Signals**

In general if operating the detector with any product which exhibits a product effect the Non Ferrous/Stainless Steel sensitivity will decrease.

## Features of your Metal Detector

### Product Numbers

When installed on a product line there may be many different types of product passing through the metal detector at different times.

To get the maximum performance from your metal detector these different products may require different settings for sensitivity and the phase control. For this purpose Safeline metal detectors can store settings for up to 21 products. These settings may then be recalled by the operator, as required, by selecting a specific 'product number' for each product name in the detector.

### Timer Groups

Experience has shown that although there may be a need for up to 21 product settings for the sensitivity and phase control, the type of reject mechanism used by the 21 products falls into one of a few groups. Safeline metal detectors allow the engineer to set up a reject mechanism/timer type once and associate this with a timer group.

Individual product numbers can then be assigned to one of these timer groups.

This means that the reject timers do not have to be set 21 times - just once for each group.

In general, only one timer type and setting will be required for most applications.

### Timer Types

A wide range of timer types and settings are available to the engineer.

Five different timer types are supported by Safeline metal detectors, each type has programmable settings.

Each timer group may be set as either of the following timer types:

Timer **tm1** is a simple reject timer without any delay time.

Timer **tm2** is a delayed reject timer for use in fixed speed applications.

Timer **tm2G** is a gated version of **tm2** allowing for more accurate rejection of discrete product.

Timer **tm3** is a variable speed version of **tm2**

Timer **tm3G** is a variable speed version of **tm2G**

### Automatic Setup

This is a feature that allows phase control and sensitivity, and frequency of operation (multi-frequency option only) of the metal detector to be set up automatically.

### Product Signal Cancellation (PSC) (option)

Phasing out a product effect signal whether manually or automatically very often does not eliminate the product signal entirely. The remaining signal normally means that the detector's sensitivity must be reduced to eliminate the product signal entirely, and this in turn leads to reduced performance.

Product signal cancellation aims to eliminate any remaining product effect signal without the need for running at reduced sensitivity.

A pack sensor must be fitted for this option.

### Automatic Tracking (option)

Some products have characteristics that may vary with time or temperature, for example, this feature will minimise this effect by adjusting its preset settings automatically in order to maintain optimum spherical performance.

A pack sensor must be fitted for this option.

### Inverse Detection

This feature is used in applications where the absence of a metal contaminant, rather than the presence of one, needs to be detected.

A gated timer must be used with this feature.

## QUALITY ASSURANCE SUPPORT (OPTION)

### (Performance Validation Routines -PVR

Two modes of detector operation, (QA Inspector mode and QA Operator mode) help the user comply with ISO 9000 and BS5750, by ensuring that the metal detector system is tested and operating to the user's specified quality assurance standards of performance.

Information may be transferred directly from the metal detector to paper by using a printer. Refer to Appendix C for sample printouts.

Timed requests for a check of the metal detector can be set.

Logging of rejects and logging of changes in the detectors settings can be set and these can be printed out on a timed basis e.g. for companies operating 8 hour shifts - once every 8 hours.

### Serial Communications

The metal detector has a serial communication port.

The link is a two wire serial connection to allow information to be transferred to and from the metal detector. Refer to Appendix D for more information

### Questions

- First time user ?
- Want some help in setting up ?
- Dont know where to start ?

### Answer

⇒ Use our step-by-step “guides”  
turn to page 21 now!

## TECHNICAL SPECIFICATION

### Technology

High frequency low power electromagnetic coil system - monitored and controlled by a microprocessor system.

### Frequency of Operation of Coil

Crystal controlled in the range 10 kHz to 1 MHz.

Multifrequency (optional) and single frequency units are available.

### Product throughput speed

Selectable.

#### Normal

0.1 to 2.0 m / min / mm of aperture height  
(8 to 160 ft / min / inch of aperture height)

#### Variable

0.05 to 2.5 m / min / mm of aperture height  
(4 to 200 ft / min / inch of aperture height)

#### Fast

0.05 to 7.5 m / min / mm of aperture height  
(4 to 600 ft / min / inch of aperture height)

Higher and lower speeds are available on request.

### Power Input

Voltage 100 to 240 Volts A.C..  
+10% / -15%

Power 100 VA \*

Frequency 50 to 60 Hz.

For connection to TN (EN60950:1992) power distribution systems only. For connections to other power distribution systems please contact your supplier.

\* Assumes no loads on the switched power outputs.

### Internal Battery

Discharge time off typical 6 months from power at temperature of 20°C

Battery life typical 5 years

Nominal voltage 3.6 Volts D.C.

### Temperature Range

Operating -10 °C to +45 °C (14 °F to 110 °F)

Storage -10 °C to +50 °C (14 °F to 120 °F)

### Humidity Range

Maximum relative humidity 93% for temperatures up to 45°C.

### Warm Up Time

Zero seconds at an ambient temperature of 20 °C

### Environmental Protection

Painted version IP66, NEMA 4

Stainless steel version IP66, NEMA 4X

For more hostile environments a protective cover is available for the control panel.

To achieve the specified protection the module and power unit cover must be torqued down to 5 Nm (45 in.lbs), or 4.5 Nm (40 in.lbs) for the module if the environmental protection cover is used.

### Sound Output

Less than 62 dBA at a distance of 1 m (without printer).

### Switched Power Output

Switched by detector ON/OFF switch.

Switched live and neutral, non-switched earth. Not internally fused.

Maximum current 1 A

### Reject Relay

Volt free changeover contacts that operate on the detection of metal.

Maximum power 500 W

Maximum current 3 A (non-inductive)

Maximum voltage 250 Volts A.C., or 30 Volts D.C. (non-inductive)

# TECHNICAL SPECIFICATION

## System Fault Relay (Optional)

Volt-free changeover contacts that operate when the Reject Confirmation Unit signals a reject fault.

Contact rating see **Reject Relay**.

## Detect Signal

Operates on the detection of metal.

|                 |                    |
|-----------------|--------------------|
| Output type     | NPN open collector |
| Maximum voltage | 35 Volts D.C.      |
| Maximum current | 100 mA             |

## Fault/Detector Active Output

Output that operates if a fault occurs in the metal detector or the detector is inactive.

|                 |                    |
|-----------------|--------------------|
| Output type     | NPN open collector |
| Maximum voltage | 35 Volts D.C.      |
| Maximum current | 100 mA             |

## Q.A. Due/Overdue Output

Output that operates when a performance test becomes due or when a performance test becomes overdue.

|                 |                    |
|-----------------|--------------------|
| Output type     | NPN open collector |
| Maximum voltage | 35 Volts D.C.      |
| Maximum current | 100 mA             |

## Pack Sensor Requirements

|                   |  |
|-------------------|--|
| Operating voltage | 15 Volts D.C.  |
| Operating current | 30 mA maximum  |
| Output type       | NPN or PNP open collector (must be same as Speed Sensor) |

## Speed Sensor Requirements

|                    |   |
|--------------------|---|
| Operating voltage  | 15 Volts D.C.   |
| Operating current  | 30 mA maximum   |
| Output type        | NPN or PNP open collector (must be same as Pack Sensor) |
| Output pulse width | 10 ms minimum   |
| Output frequency   | 50 Hz maximum   |

## Reject Confirmation Sensor Requirements

|                   |                           |
|-------------------|---------------------------|
| Operating voltage | 15 Volts D.C.             |
| Operating current | 30 mA maximum             |
| Output type       | NPN or PNP open collector |

## RS232 Serial Communications

Two communication ports COM1 and COM2 are available from within the power unit enclosure.

Voltage levels as per RS232 standard, typically  $\pm 9$  volts.

|               |      |
|---------------|------|
| Baud rate :   | 9600 |
| Data bits :   | 1    |
| Start bits :  | 1    |
| Stop bits :   | 1    |
| Parity bits : | 1    |
| Parity type   | Odd  |

COM1 - 2 or 4 wire control for use with printer (Hardware handshaking is only possible with 4 wire control).

COM2 - 2 wire control for communications with metal detector.

## Internal Counters

### Reject Counter

Counts reject relay operations, not the number of detections, or the number of rejects.

Counter range 0000 to 9999

This counter is resettable from the control panel.

### Pack Counter

This counter requires that an external pack sensor be fitted.

Counter range 00000000 to 16,777,214

Maximum count rate 3000 packs/min at a pack/space ratio of 1:1.

This counter is resettable from the control panel.

*Note. When the maximum counter value is reached, the next increment will change the digits to \*.*

## Spherical Sensitivity

Dependent on aperture size, and frequency of operation, all sensitivity information is expressed in diameters of spherical samples.

Non spherical objects such as wires will exhibit an orientation effect, ie. they can be more easily detected in certain axis. If the diameter of the wire is less than the spherical sensitivity setting the sample may not be detected in all orientations.

## Sensitivity Ratios

Dependent on frequency of coil system e.g. at 300 kHz

Non Ferrous x 1.1 to 1.3 Fe diameter (depending on the metal)

Stainless Steel x 1.2 to 1.5 Fe diameter (depending on type, most difficult to detect is type 316)

## Sensitivity Gradient

Less than two diameters.

This is the difference in sensitivity measured at the centre of the aperture and the sensitivity at any other point in the aperture not closer than 10 mm to the surface.

## Timer Ranges

Timer type **tm1**

Type: Simple reject timer.

Reject time has a range of 50 ms to 60 s.

Timer types **tm2** and **tm2G**

Type: Fixed speed delayed reject timers.

Reject time has a range of 50 ms to 60 s.

Delay time has a range of 50 ms to 60 s. (0 ms delay time is also possible)

Timer types **tm3** and **tm3G**

Type: Variable speed delayed reject timers.

Signal shift with a range of 1 to 128 speed sensor pulses.

Reject shift/time with a range of 1 to 256 speed sensor pulses or 50 ms to 60 s.

## GENERAL

Carefully study the following sections; a little care taken during installation will avoid the detector's performance becoming severely impaired.

Most of the detectors high frequency magnetic field is contained within the metal case of the detector head. Unavoidably there is some leakage of the magnetic field from the aperture of the detector.

It is the effect of the leakage magnetic field on the surrounding metalwork that may influence the detectors performance and can give rise to inconsistent performance.

A little care when installing the detector will be rewarded by a consistent, highly reliable metal detector performance.

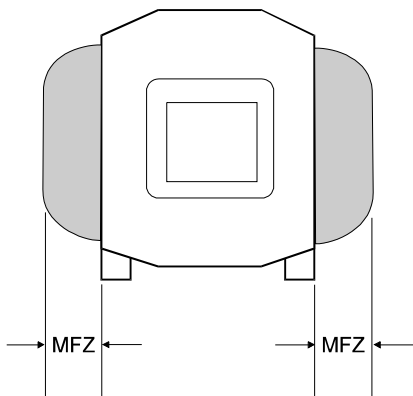
## MECHANICAL INSTALLATION

### Metal Free Zone (MFZ)

To achieve optimum metal detector performance, an area surrounding the aperture of the detector known as the MFZ should be kept free of metal.

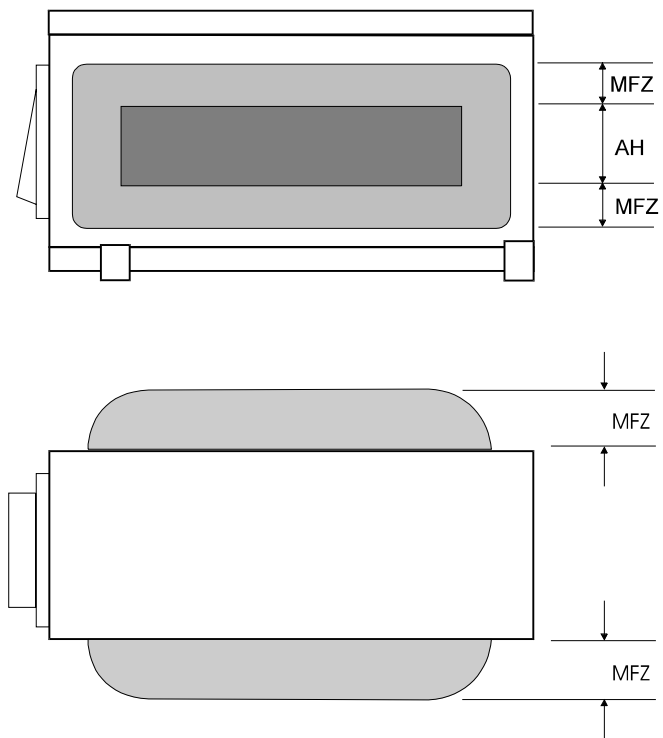
The size of the MFZ will be dependent upon the aperture height (AH), the type of detector and the operating sensitivity.

Stationary metal may be positioned closer to the detector than moving metal. MFZ guidelines for standard series detectors are shown in Figure 4. Please consult the product data sheet for the MFZ of other types of metal detector.



$MFZ = 1.5 \times AH$  for stationary metal

$MFZ = 2 \times AH$  for moving metal



**Fig 4 Metal Free Zone Guidelines**



## Construction of the Detector Installation

The design and construction of the metal detector support framework will influence the performance of the detector.

Follow the guidelines below to obtain the best performance.

- Insulate one end of the roller from the conveyor frame.
- This can take the form of a plastic insulation plate and washers on the bearing mounting block or a plastic extension to the end of the roller shaft (see Fig. 6).
- The conveyor frame should be of welded construction rather than bolted sections.
- Insulate/isolate all items bolted to the frame (eg guards) using non-conducting insulators.
- Mount the detector to its support framework using the four plastic insulation sets supplied with the detector.
- Avoid passing metal conduit or electrical cables through the metal free zone or near the aperture of the metal detector.
- See Appendix E for the theory behind the construction of the metal framework.

A typical installation is shown in Figure 5.

## Positioning the Detector Head

Better sensitivity will be achieved if vibration from other machines is isolated from the detector.

- Avoid supporting the detector head on or near vibrating structures and/or machines subject to mechanical shock.
- Position the detector head to allow easy access to the control panel.
- Position the detector to allow removal of the control unit for servicing.

## Electrical Connections



**If the detector is supplied as part of a system, read all the system literature before commencing electrical installation**

In order to reduce the possibility of problems with electrical interference, do NOT run any metal detector cable next to other cables carrying switched or heavy loads.

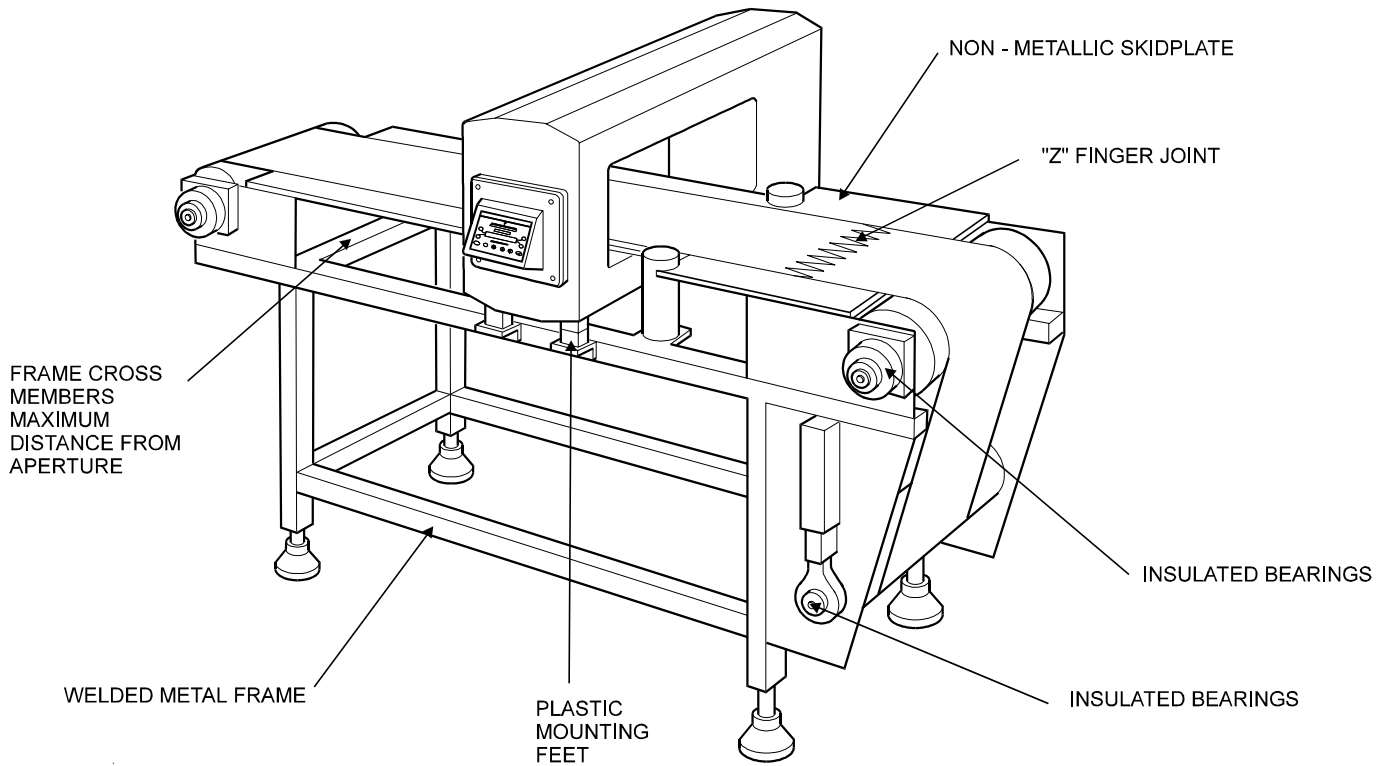
Electrical connections to the power unit are as shown in Figure 8

Power connections to the power filter (where fitted) are shown in Figure 9.

Arrangement of the gland assemblies for connecting the power cable to the power supply unit are shown in Figure 10.

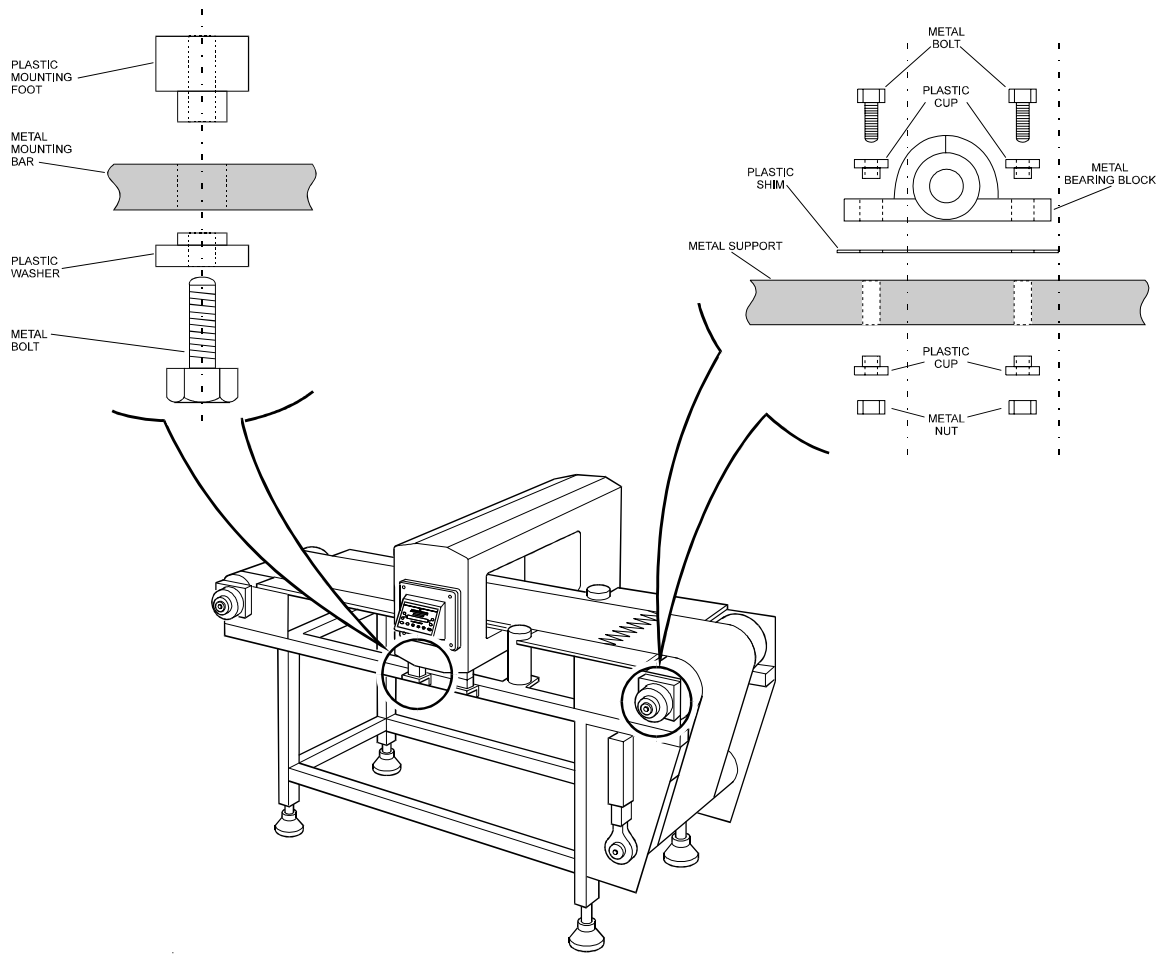
Note. When installed correctly, the detector head should be electrically insulated/isolated from the support structure and connected to earth/ground only through its own electrical connections.

These instructions are for connection to TN (EN60950:1992) power distribution systems only. For connections to other power distribution systems please contact your supplier.

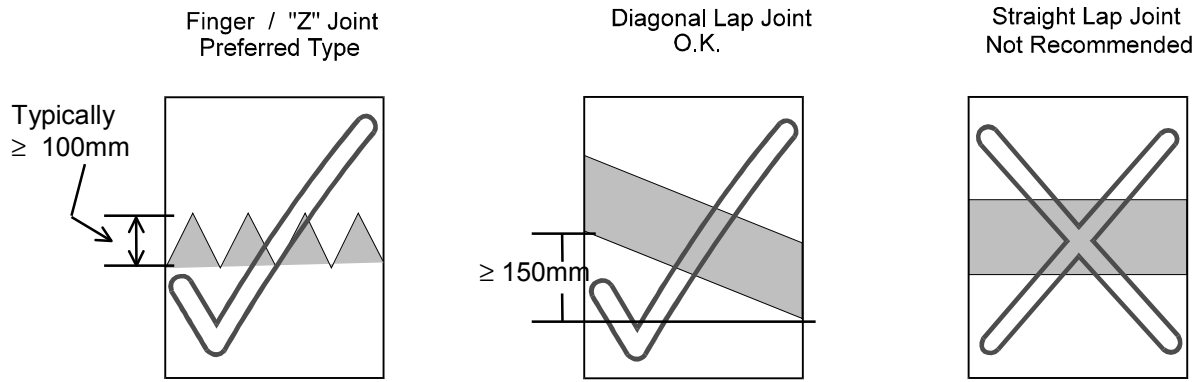


**Fig 5 Typical Metal Detector Conveyor**

# INSTALLATION



**Fig 6 Bearing Block And Mounting Foot Insulation**



**Fig 7 Belt Joints**

## ELECTRICAL INSTALLATION



Ensure all power has been disconnected from the detector before attempting to work on any electrical components of the detector.

### General

When installing the detector do NOT position the power cable adjacent to other cables carrying switched or heavy loads (this will reduce the possibility of electrical interference affecting detector operation).

### Location and Layout of the Detector Terminals

Access to the detector terminals is gained by removing the power supply box lid, as detailed in the next section.

Once the power supply box lid has been removed, the terminals can be accessed.

The layout of the terminals is shown in Figure 8.



The following procedure should only be carried out by qualified Safeline personnel or qualified Safeline agents.

### Removing the Power Supply Box Lid

- 1) To remove the power supply box lid, remove the four screws.
- 2) Raise the power supply box lid.
- 3) Lift the power supply box lid completely away from the power supply box.

To refit the power supply box lid ensure that the seal around the box lid is in place and undamaged then carry out the above procedure in reverse order.

### Wiring and circuit breaker details

Details of the power connection to the detector power filter (where fitted) and the position and rating of the recommended circuit breaker are shown in Figure 9.

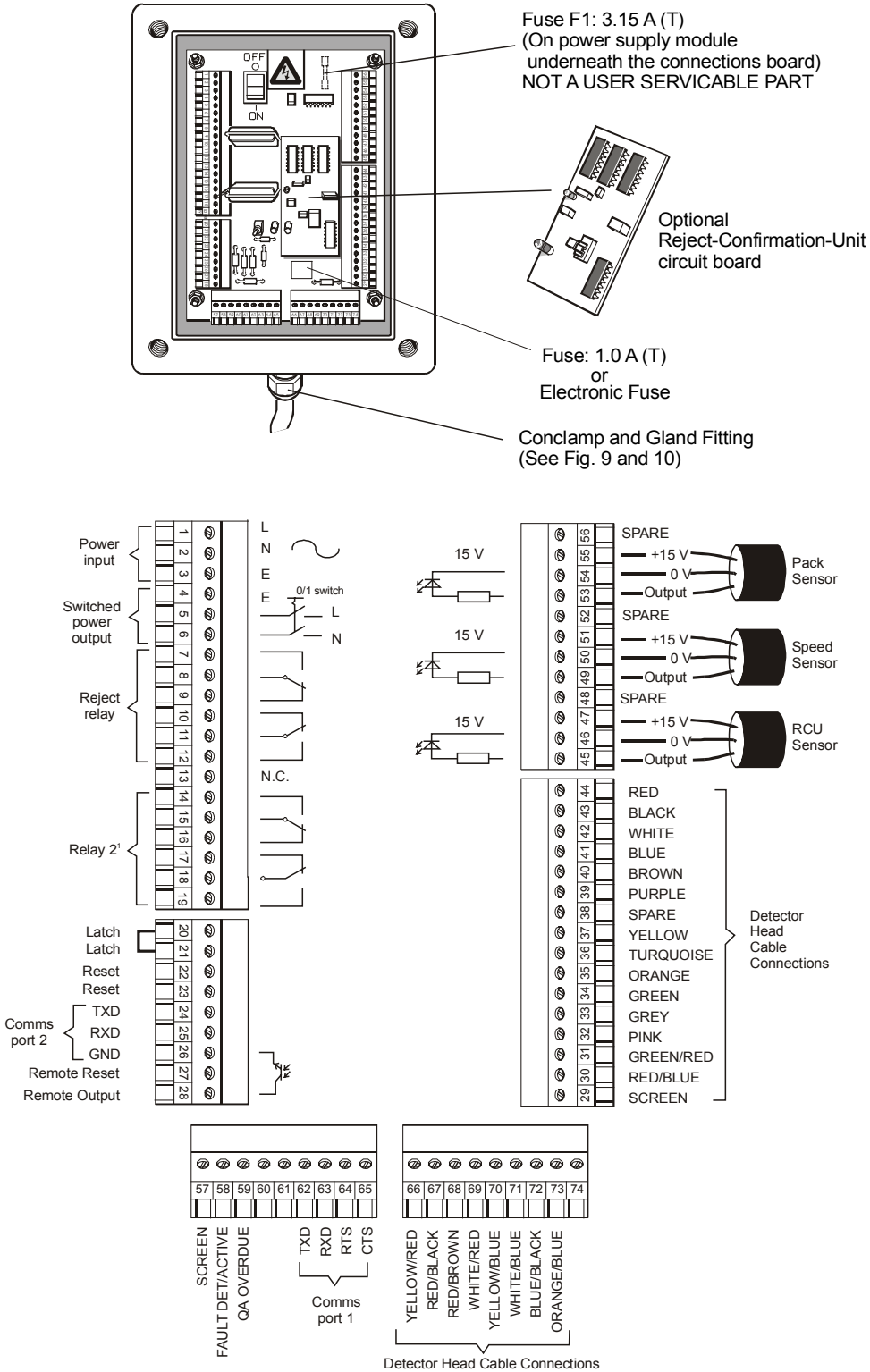
Arrangement of the gland assemblies for connecting the power cable to the power supply unit are shown in Figure 10.

## Questions

- First time user ?
- Want some help in setting up ?
- Dont know where to start ?

## Answer

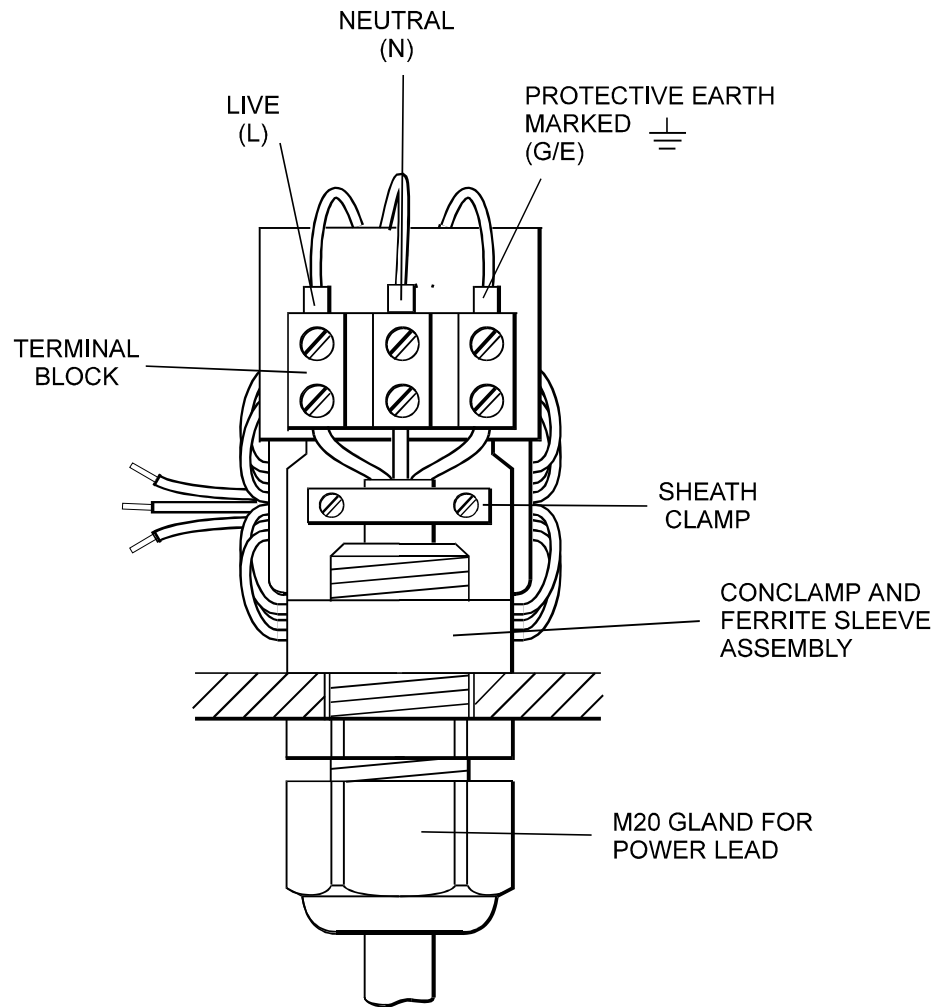
⇒ Use our step-by-step “guides”  
turn to page 21 now!



- 1) LINK 2 MUST BE FITTED IF THE MODULE HARDWARE IS LESS THAN VERSION 62 (INTRODUCED 25/10/93) AND DOES NOT INCLUDE REJECT CONFIRMATION.
- 2) METAL DETECTION RELAY CONTACTS - RL1. THE RELAY CONTACTS CHANGE FROM THE STATE SHOWN WHEN METAL IS DETECTED
- 3) SYSTEM FAULT RELAY CONTACTS - RL2.(OPTIONAL). THE RELAY CONTACTS CHANGE FROM THE STATE SHOWN IF THE REJECT CONFIRMATION UNIT SIGNALS A REJECT FAULT OR THE METAL DETECTOR SIGNALS A HEAD OR MODULE

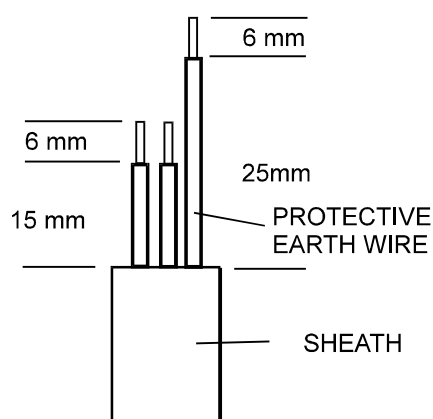
**Fig 8 Layout of components and Terminals**

# INSTALLATION



## CONCLAMP TERMINAL ASSEMBLY

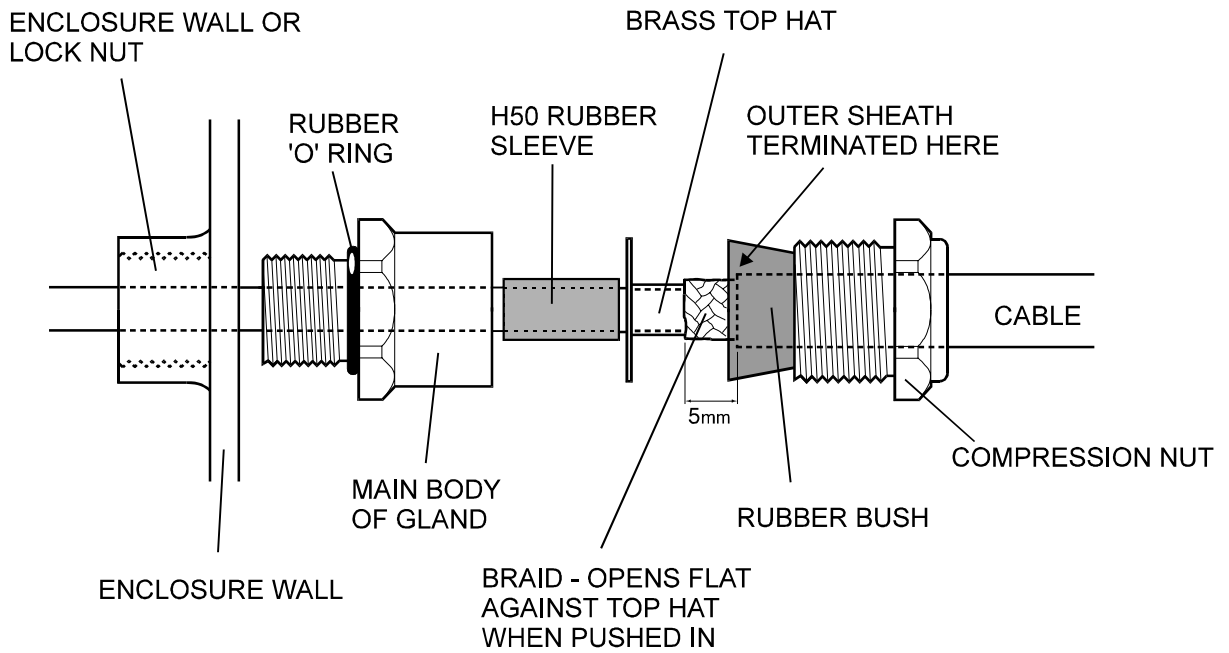
### RATINGS



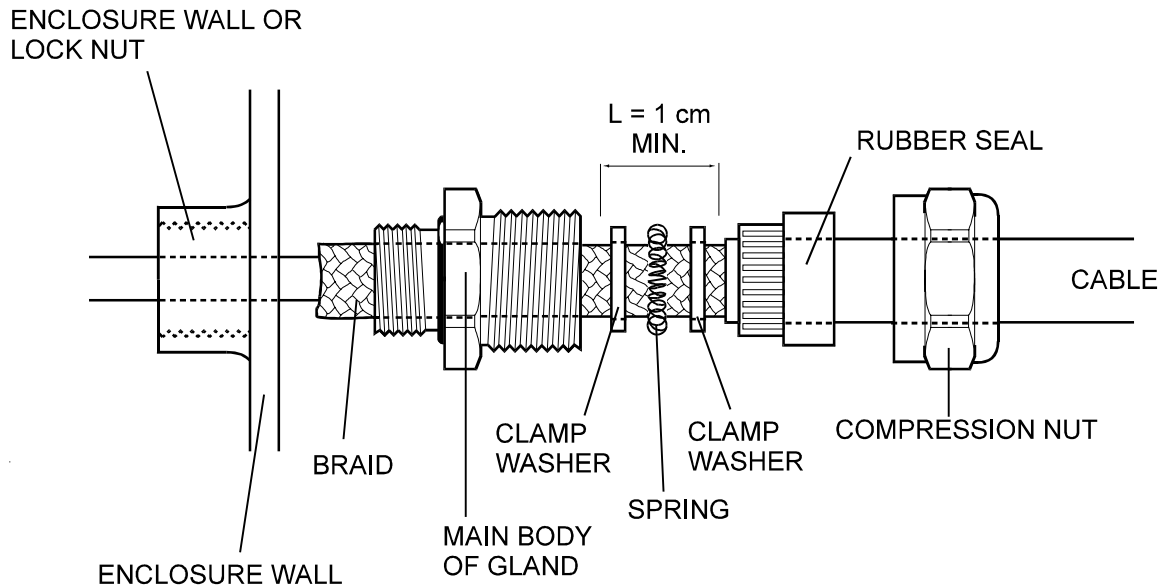
### POWER LEAD PREPARATION

- 1) RECOMMENDED MAINS LEAD  
 AREA  $0.75^2$  mm  
 CONSTRUCTION 24 x 0.2 mm  
 CURRENT RATING 6 AMP.  
 COLOURS BROWN-LIVE, BLUE-NEUTRAL,  
 GREEN/YELLOW-EARTH.
- 2) a) RECOMMENDED CIRCUIT BREAKER  
 DOUBLE POLE, CURRENT RATING 3 AMP  
 OR 4 AMP, TYPE C CIRCUIT BREAKER TO  
 BE MOUNTED CLOSE TO EQUIPMENT.  
 OR  
 b) RECOMMENDED FUSE RATING  
 CURRENT RATING 4 AMP OR 5 AMP  
 ANTI-SURGE (T).

Fig 9 Power Connections to the Detector



STANDARD HEAD TERMINATION CABLE GLAND ASSEMBLY



EMC FEEDTHROUGH TYPE CABLE GLAND ASSEMBLY

Fig 10 Cable Gland Assemblies for Power Supply Unit

## INTRODUCTION

### The Control Panel

The metal detector control panel (see Figure 11) is the interface by which the user may observe and control the metal detector's performance. All of the metal detector's operating characteristics may be programmed through the control panel.

A Liquid Crystal Display (LCD) shows the information contained in the metal detector's computer. With this display and by using the touch keys the metal detector's performance is controlled.

With the help of the 2-colour bargraph display, the user may observe the signals generated by metal contaminants or products passing through the metal detector.

When the signal from the detector is large enough to illuminate one or more red LEDs on the 2-colour bargraph display, a detect indicator in the centre of the control panel will illuminate.

The detect indicator will remain illuminated until the signal from the LED bargraph is equal to or less than 10 green LEDs.

The detect indicator will also illuminate if any faults occur with the detector

Changing the metal detection characteristics can only be achieved by gaining access to the metal detector's computer. Access is restricted by the use of a security code. Different security codes enable different modes of operation. In this way the control of particular parameters may be restricted to certain personnel or user groups.



**Remember to record all settings in the Settings Sheets at the rear of the manual.**

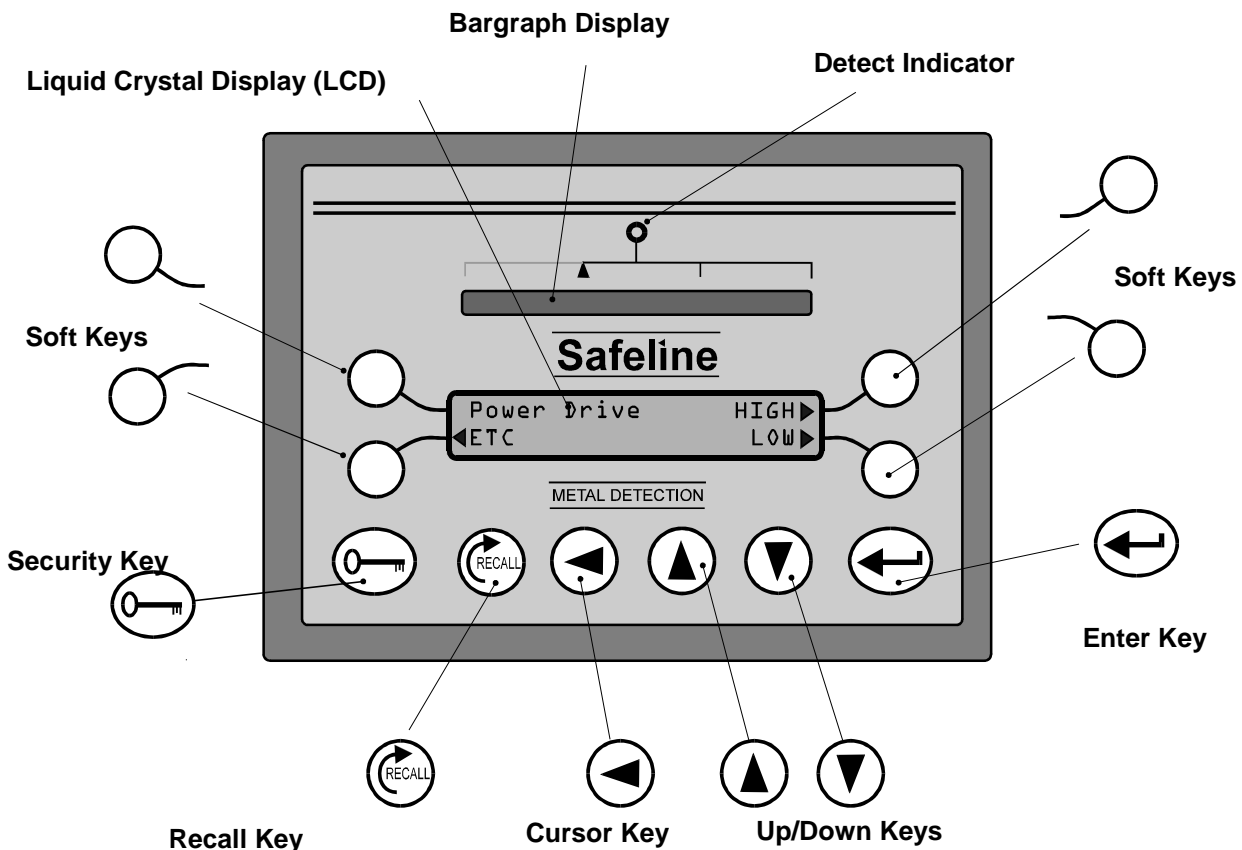



Fig 11 Control Panel



## The Page Display System

There is a requirement to display more than the LCD can display at any one time.

To expand the display capabilities a page display menu system is used. This can be compared to the pages of a book. When there is more than one page of information to be displayed the word ETC will appear on the display. Pressing the appropriate soft key adjacent to ETC will cause the display to move to the next page or scroll forward. To turn back to the previous page or scroll backwards press the Recall key. Using this technique many pages of information can be stored in the computers memory and displayed as required.

On the LCD a small  pointer may appear adjacent to the soft key. This indicates that a particular parameter can be changed.

If the parameter to be changed is a number and the appropriate soft key is pressed the pointer will now point inwards towards the number to be adjusted and a cursor bar appears under the digit to be changed. (Refer to Changing Numeric Values for further information).

If the parameter to be changed is not a number but requires the user to make a choice, i.e. ON or OFF, YES or NO the current selection will be indicated by a flashing marker on the display.

## The Touch Keys Explained

### Soft Keys

The function of the four soft keys is controlled by the computer software and will change dependent upon where you are in the program.

---

#### Cursor Move Key

This key is used to control the movement of the cursor bar when changing the setting of a numeric value

A small cursor bar will appear under the active digit on the LCD display when a parameter is available for adjustment

Example 1 2 3 4

One press of the cursor move key will move the cursor bar one step to the left,

Example 1 2 3 4.

Combined use of this key and the Up/Down keys will enable adjustment of all the digits.

NOTE:-

This key will only operate when the cursor bar is visible on the LCD display.

---

#### Up/Down keys

Use of these keys will increase or decrease the value of a particular digit.

NOTE:-

These keys will only operate when the cursor bar is visible on the LCD display.

---

#### Security key

When pressed in Running mode it will bring up the 'ENTER SECURITY CODE' display and is the first step to gain access into other modes.

If pressed whilst in any of the other modes it will exit the current mode and return to the Running mode display.

---

#### Enter key

Used to enter data into the computer memory. For example when changing the sensitivity on the display it is necessary to press the ENTER key to store the new value in the computer memory.

---

#### Recall key

Use this key to scroll backwards to the previous display page in the menu.

NOTE:-

The ETC soft key is used to scroll forward

# OPERATING INSTRUCTIONS

## Entering security codes.

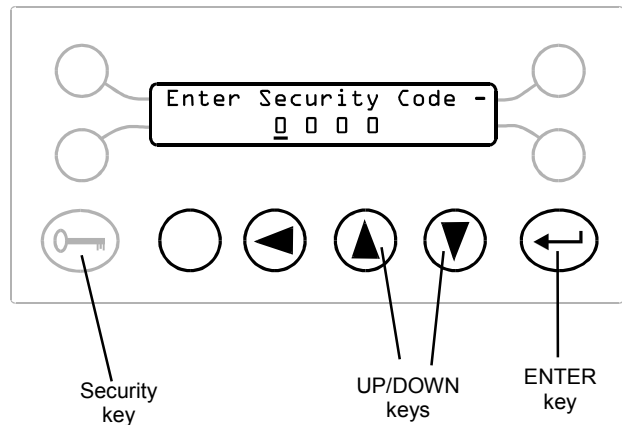
To prevent unauthorized access to the detector all settings have to be performed from a different operating mode than the default Running Mode.

To change to another operating mode the user must enter a four digit security code.

The instructions below detail how to enter a security code.

- 1) Press the Security key.
- 2) Use the Up and Down keys to alter the digit the cursor is underneath.
- 3) When the correct value is showing on the digit press the Enter key.
- 4) The cursor will move one position to the right and the entered digit will be replaced by an asterix character, \*.
- 5) Repeat steps 2) to 4) for all four digits.
- 6) When the final digit is entered the detector will either;
  - a) Go to the first display of the operating mode whose security code was successfully entered
  - or
  - b) Return to the Running Mode display if an incorrect security code was entered.

Note.  
Default values for the security codes can be found in the Introduction part of the Security Setup section, later in the manual, and at the start of the relevant section of this manual.



## Changing Numeric Values

Various settings in the program are stored as numbers, eg product number, sensitivity, etc.

Numeric values can only be adjusted if a ► pointer is visible on the LCD display adjacent to the parameter to be adjusted and pointing toward the adjacent soft key.

The display opposite shows two adjustable numeric parameters, on the right of the display.

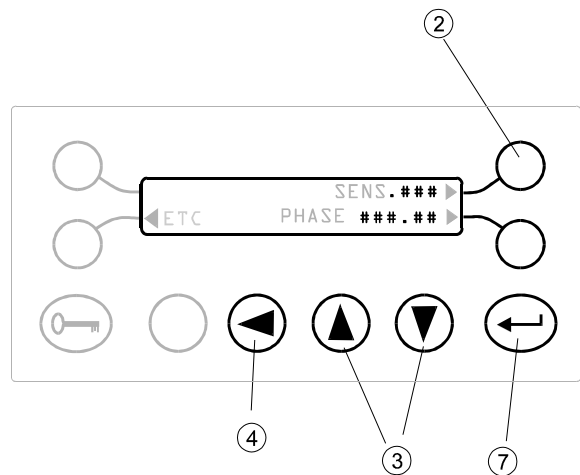
If a ► pointer is not visible the value of that parameter cannot be changed in the current mode.

### Note:

If the adjustable parameter is on the left side of the display it will be indicated by a ◀ pointer, which will change to a ► pointer when selected.

To change the numeric value of a particular setting use the following procedure.

- 1) Enter security code, and press the ETC softkey until the correct page is shown.
- 2) Press the soft key adjacent to the parameter (2) to be adjusted. The ◀ pointer will now point inwards towards the parameter and a cursor bar will appear under the first digit of the number.
- 3) Press the Up/Down keys (3) and adjust the digit to the required value.
- 4) Press the cursor move key (4) to move the cursor bar to the next digit.
- 5) Repeat step 3).
- 6) Repeat steps 3) and 4) for each digit to set the required value.
- 7) Press the (7) key to store the new value in memory.



## INTRODUCTION TO THE GUIDES

The following guides are intended to help users setting up a detector for the first time.

The guides are written as a sequence of step-by-step references to instructions in other sections of this manual.

The guides highlight settings which have to be adjusted for most applications before correct operation of the detector may begin.

Before attempting to use the 'guides' the operator should read the following sections of this manual :

- 1) Principles Of Operation, page 1
- 2) Features, page 3
- 3) The Control Panel, page 17
- 4) The Page Display System, page 18
- 5) Entering Security Codes, page 19
- 6) Changing Numeric Values, page 20



Don't worry if you didn't understand everything in the sections above. The guides make things easy !

There are four guides:

- a) **Universal Settings Guide.**  
This guide lists the settings which control various operating characteristics of the detector. These settings may be altered to suit the particular requirements of the application. The word "Universal" is used as these settings affect all product numbers.
- b) **Product Number Settings Guide.**  
The detector has the ability to store settings for 21 different product numbers. Each product number contains a group of settings which are set to optimise the detector performance for a particular product. This guide takes the user through the setting up of this group of settings for particular product types.
- c) **Performance Validation Guide.**  
The detector supports many features that can be used to validate the performance of the detector. This guide takes the user through the required settings for performance validation (quality assurance) operation.
- d) **Speed Change Guide**  
If the product speed changes a number of settings will need adjusting to compensate for the change in speed. This guide takes the user through the required setting up following a change in the operating speed of the product.

---

### Introduction To The 'How to...' Boxes

Alongside the guides you will find a few boxes with titles that begin with the words 'How to...'

These boxes detail in a step-by-step fashion how to perform certain simple routines with your detector;

e.g. 'How to... Print',  
'How to... Carry out a Performance Test'.  
etc.



Please remember to record all settings in the Settings Sheets at the rear of the manual.



Item(s) referred to in some guides may be options not available on your detector - if so ignore the item(s).

## Universal Settings Guide

---

### Introduction

**The following settings affect the detector operation independent of the current product number. This guide should be the first guide used.**

---



NOTE

All of the items below may be set whilst product number 0 is selected as the current product number.



NOTE

All of the following items may be set from the Engineer Mode of operation.

---

- |   |  |
|---|--|
| 1) <b>'Language'</b> on page 49.  | <i>Set the appropriate language for the displays.</i>  |
| 2) <b>'Set Date And Time'</b> on page 50.                                   | <i>Set today's date.</i>   |
| 3) <b>'Set Date And Time'</b> on page 50.                                   | <i>Set the current time.</i>   |
| 4) <b>'Reject Inhibit'</b> on page 48.                                      | <i>If you want to prevent the reject device activating whilst setting up the detector.</i>   |
| 5) <b>'Product speed'</b> on page 47.                                       | <i>Set up the speed of the product - either manually or automatically.</i>                   |
| 6) <b>'Vibration Setup'</b> on page 47.                                     | <i>Set up the detector to the vibration characteristics of your system.</i>                  |
| 7) <b>'Pack sensor setup'</b> on page 47.                                   | <i>If you intend using a pack sensor or those features that require a pack sensor.</i>       |
| 8) <b>'Reject Timers'</b> and subsequent timer sections on pages 45 and 82. | <i>Set up the required timer groups to the appropriate timer types and settings.</i>         |
| 9) <b>'Security Setup'</b> on page 47.                                      | <i>Set up the security codes for entry into the various operating modes of the detector.</i> |



NOTE

In the majority of cases there will be no need to adjust the following items. The following items are shown here for completeness.

# OPERATING INSTRUCTIONS

10) **'Detection Buzzer'** on page 48.

*Set whether you want the internal buzzer to sound at detection.*

11) **'Reject Confirmation'** on page 49.

*If you are using the reject checking facilities of the detector.*

12) **'Automatic Tracking Setup'** on page 48.

*If you will be using the Automatic Tracking option, set up the universal settings for this feature.*

13) **'Boost Mode'** on page 49.

*At or near to full sensitivity a further 20% sensitivity improvement may be possible.*

## Product Number Settings Guide

---

### Introduction

***This guide should be performed for each product type that will be monitored by the detector.  
The majority of products which have no product effect will operate on a single product number.  
This guide sets all product-dependant settings of the detector.***

---



NOTE



NOTE

The '**Universal Settings Guide**' should be used before this guide.

All of the following items may be set from the Engineer Mode of operation.

---

1) '**Product Number and Automatic Setup**' on page 43.

*Select the required product number to set up next.*

2) '**Select and Update Timer**' on page 42.

*Select the timer group for the product number.*

3) '**Inverse Detection**' on page 42.

*If the product number is an inverse detect application then select Inverse Detect.*

4) '**Automatic setup**' on page 50.

*Use the automatic facility of the detector to set the phase and sensitivity.*

5) '**Product Signal Cancellation**' on page 43.

*If required then select the Product Signal Cancellation feature.*

6) '**Automatic Tracking**' on page 45.

*If required then select the Automatic Tracking feature.*

7) Go back to step 1) above for the next product to be set up.

*Finally change the product number to the product number that is to be used next.*

8) '**Product Number and Automatic Setup**' on page 40.

*If this feature was enabled during **the 'Universal Settings Guide'** then disable it after completing this guide.*

9) '**Reject Inhibit**' on page 45.

## Performance Validation Guide

---

### Introduction

*This guide will lead you through setting up the performance validation features of the detector.*

---



NOTE

The '**Universal Settings Guide**' should be used before this guide.



NOTE

The '**Product Number Settings Guide**' should be used before this guide.



NOTE

All of the following items may be set from the QA Inspector Mode of operation.

- 1) '**Test Samples**' on page 69.
- 2) '**Test interval**' on page 71.
- 3) '**Overdue Period**' on page 71.
- 4) '**Change QA Operator Code**' on page 72.

*Set up the test ball sizes that the operator will be prompted to pass through the aperture when performing validation tests.*

*Set up the test interval so the detector will prompt the operator to perform Performance Validation Tests at regular intervals.*

*Set up the amount of time to allow after prompting for a test before the test is considered overdue.*

*Set up the security codes (maximum of 9 separate codes) for the operators who will be performing the Performance Validation Tests.*

### **How to... 'Carry out a Performance Validation Test'**

Step 1)

Enter one of the QA Operators security codes.

**'Entering security codes'** on page 19.

Step 2)

Select the material of the test sample.

**'Select Test Material'** on page 74.

Step 3)

Pass the test sample with the product through the detector aperture.

**'Select Test result'** on page 75.

Step 4)

Go back to Step 2) if testing more samples, else press the PROG/EXIT key.





NOTE

You have now set up the minimum requirements of a performance validation system. The following items will set up additional Performance Validation features.

5) **'Alarm if DUE or OVERDUE'** on pages 71.

*Select the operation of the output from the detector that gives remote warning of a Performance Test becoming DUE or OVERDUE.*

6) **'Printer Fitted'** on page 72.

*Select whether a printer is to be used.*

7) **'Printer Fixed or Portable'** on page 68.

*Select whether a printer will be permanently connected.*

8) **'Line Identification'** on page 68.

*Enter a 4 digit identifier that will appear on all printouts, (useful where more than one detector is being operated).*

9) **'Shift report options'** on page 69.

*Select what should appear on shift printouts.*

10) **'Shift report start'** on page 70.

*Set the starting time for the automatic shift printouts.*

11) **'Shift report Interval'** on page 70.

*Set the time between the automatic shift printouts.*

## ***How to... 'Print from the keypad'***

Step 1)

Enter the QA Inspector security code.

**'Entering security codes'** on page 19.

Step 2)

Select the QA Inspector Print Menu.

**'QA Inspector Print Menu'** on page 72.

Step 3)

Select the type of printout required - either 'Print All Settings' or 'Print The Shift Report'.

**'QA Inspector Print Menu'** on page 72.

Step 4)

Press the PROG/EXIT key.

## Speed change guide

### Introduction

*This guide details in a step-by-step manner all settings that may have to be changed if the speed of operation of the detector is changed.*



NOTE

All of the following items may be set from the Engineer Mode of operation

- |   |  |
|---|--|
| 1) <b>'Product speed'</b> on page 45.                                       | <i>Set up the speed of the product - either manually or automatically.</i>   |
| 2) <b>'Vibration Setup'</b> on page 44                                      | <i>Set up the detector to the vibration characteristics of your system.</i>  |
| 3) <b>'Reject Timers'</b> and subsequent timer sections on pages 42 and 78. | <i>Set up the required timer groups to the appropriate timer type and settings. Note this step is NOT required for timers which are synchronised to the product speed (e.g. tm3 and tm3G timer types).</i> |
| 4) <b>'Reject Confirmation'</b> on page 46.                                 | <i>If you are using the reject checking facilities of the detector.</i>  |
| 5) <b>'Product Number Settings Guide'</b> on page 23.                       | <i>See the earlier guide.</i>  |

### ***How to... 'Measure the speed of the product'***

- |   |  |
|---|--|
| Step 1)<br>Enter the Engineer security code.  | <b>'Entering security codes'</b> on page 19. |
| Step 2)<br>Select the Speed Setup Menu.   | <b>'Speed Setup Menu'</b> on page 45         |
| Step 3)<br>Select the 'Auto Adjust' feature and follow the instructions on the display.                   | <b>'Product Speed'</b> on page 63.           |
| Step 4)<br>On completion of step 3) the Product Speed display will show the current speed of the product. | <b>'Product Speed'</b> on page 63.           |
| Step 5)<br>Press the PROG/EXIT key.   |  |

## MANUALLY SETTING THE DETECTOR FOR A PRODUCT

### General

At this stage the metal detector should have been installed and the user should be familiar with the principles of operation, basic operation of the control panel, and have worked through the universal settings guide as described in previous sections.

The Safeline detector has the ability to store settings for 21 different product numbers. Each product number represents a group of settings, the appropriate setting of sensitivity, phase, frequency, power drive, timer type, inverse detect, automatic tracking, and product signal cancellation may be allocated to each product number. Note product signal cancellation is available in five product numbers only.

Sensitivity, phase, frequency, and power drive when set correctly will optimise the detection sensitivity. The timer type will optimise reject operation, for different pack lengths or product speed. Inverse detection will allow the action of the reject timer to be reversed, allowing product with no metal contamination to be rejected whilst metal contaminated product is accepted. Automatic tracking will ensure that the products sensitivity and phase value remain optimised for products with varying product effect characteristics. Product signal cancellation may give improved performance for a minority of products which present consistent product effect characteristics.

The phase control can play a dominant role in optimising the detectors performance for particular products. For many products, those which do not exhibit a product effect, the optimum setting of the detector will be with phase set at around 0°. With those products that exhibit a product effect, improved detection sensitivity can be achieved by aligning the phase control to minimise the product signal.

When making adjustments to the detector for a particular product the user should ensure that product is passed through the detector aperture in its usual manner to create a worst case product effect condition.

### Notes on Passing Product Through the Detector



The product should be continually moving, the detector will not operate with standing/stationary product in the aperture.

To ensure that the detector is set up correctly and will operate satisfactorily during normal production, we recommend that the product used for set up is passed through the detector in the worst case position and orientation which would occur during normal production.

The worst case product effect condition is when the greatest disturbance of the coil system/largest product signal is experienced. This occurs when the coil system condition changes from no product to maximum product.

If the product is a continuous length/strip, the worst case product effect is given from the leading edge/face of the product. Product fully spanning the detector head gives a much reduced signal.

With individual or boxed/cartoned product the worst case product effect condition occurs as the product enters and leaves the detector. If the product is rectangular the product effect signal will generally be more severe if the product enters the detector aperture long edge leading, as opposed to short edge leading. The gaps between the products will create the worst case product effect condition. If successive products are touching a reduced product signal will result.

For the majority of product types the worst case condition occurs the closer the product is to the faces of the detector aperture.

The technique of setting up to the worst case product effect condition will ensure that no false product rejections occur during normal running conditions.

## Manual Setup for Non Product Effect Applications

Many products exhibit little or no product effect signal when passed through the detector, these products are often referred to as non product effect or dry products. Typical dry product are paper, plastics, flour, rice, noodles, etc.



NOTE

At higher detector head operating frequencies products previously considered as dry products may start to exhibit product effects. If this is the situation use of the phase control may give better results, refer to 'Manual Setup For Product Effect Applications' below.

Manual setup may be used to optimise the detector sensitivity, phase, frequency, and power drive settings for non product effect applications.

When manual adjustment has been carried out to optimise the detector performance, the final adjustment normally required is simply a matter of setting the sensitivity control to give the required detection standard, i.e. 1.0, 1.5, 2.0 Fe etc.

Product number 00 has its phase setting fixed for non product effect applications and may be used to simplify the manual setup.

All product number settings are factory-set for non product effect applications and therefore steps 4), 5), and 6), will not be required on previously unused product numbers.

- 1) Enter Supervisor/Engineer access code, page 19.
- 2) Select the lowest available product number (01 to 20), page 40.
- 3) Set the Sens to 199, page 40.
- 4) Set the 'Phase' to 0° (default setting), page 40.
- 5) Set the 'Operating Frequency' to HIGH (default setting), page 41.
- 6) Set the 'Power drive' to HIGH (default setting), page 41.
- 7) Ensure the product is flowing through the detector in its normal manner. If a product signal is observable on bargraph display ensure the product is flowing through the detector creating worst case product effect conditions, refer to 'Notes On Passing A Product Through The Detector' earlier.

- 8) If a product signal is observable on bargraph display adjust the sensitivity control, Sens (page 43), so that the peak signal from the product gives 3 to 4 bars on the bargraph display(s). Refer to note 1) below.
- 9) Test the sensitivity of the detector by passing metal samples through the aperture of the detector (preferably positioned on or placed in the product).
- 10) If required adjust the Sensitivity (page 40) to achieve the required spherical performance standard, i.e. 1.0, 1.5, 2.0 Fe, etc.
- 11) If there are other product types to be inspected repeat this procedure from step 2).
- 12) Press 'PROG/EXIT' to return to the running mode.

### Note

1) For applications where the peak product signal indicates between 6 and 19 bars on the bargraph displays the product may be classified as either a non product effect or a product effect type. In order to determine which setup condition will give the best sensitivity it will be necessary to carry out both types of setup (i.e. Manual Setup for Non Product Effect Applications and Manual Setup for Product Effect Applications). A comparison should be made between the two sets of results and the most favourable settings selected.

## Manual Setup for Product Effect Applications

Wet/moist product, i.e. meat, cheese, fish, soups, sauces, etc. generate product signals when passed through the detector. At high sensitivity settings the signal will normally be clearly visible on the bargraph display.

Manual setup may be used to optimise the detector phase, sensitivity, frequency, and power drive settings for product effect applications.

# OPERATING INSTRUCTIONS

The objectives of the following procedure is to establish the setting of phase which will align the phase control circuit with the product signal. The correct setting will give minimum signal from the product on the bargraph display.

There will be one value of phase which will give the minimum signal, this is known as the "null point" setting. Changing the phase setting up or down in value from this setting will increase the amplitude of the signal.

It is much easier to find the correct phase setting by starting at a low sensitivity setting then repeating the process in stages at increasing sensitivities.

When using the phase control to minimise product signals the detector may become more susceptible to vibration. The final setting of the sensitivity may be limited by vibration effects rather than product effect.

- 1) Ensure product is flowing through the detector creating worst case product effect conditions, refer to 'Notes On Passing A Product Through The Detector' earlier.
- 2) Enter Supervisor/Engineer access code, page 19.
- 3) Select lowest available product number (01 to 20) , page 40.
- 4) Set the 'Operating Frequency' to HIGH (default setting), page 41.
- 5) Set the 'Power drive' to HIGH (default setting), page 41.
- 6) Adjust the sensitivity so that the peak signal from the product gives 3 to 4 bars on the LED bargraph display. If the signal is very large, such that the sensitivity control falls below a setting of 100 refer to note (1).
- 7) Press the 'Enter' key to store the new setting in memory.
- 8) Set phase to 000.00°.
- 9) Adjust sensitivity so that the peak signal from the product gives just less than full scale indication on the LED bargraph display.

- 10) To find the null point, change the phase setting to 10° and observe if the amplitude of product signal indicated on the bargraph display reduces. Repeat the process increasing the phase setting in steps of 10°, i.e. 20°, 30°, 40°, 50°, 60°, etc. until the null point is located.

For example if as the phase setting is increased there is clear reduction in signal from 80° to 90°, and then from 90° to 100° the signal starts to increase again, this indicates that the null point is between 80° and 100°.

- 11) Now reduce the phase setting in steps of 2° i.e. 98°, 96°, 94°, 92°, etc. the product signal indicated on the bargraph display should now reduce in amplitude. Decrease the phase setting in steps of 2° until the product effect signal is reduced to a minimum and then starts to increase again.

For example if as the phase setting is reduced there is clear reduction in signal from 94° to 92°, and then from 92° to 90° the signal starts to increase again, this indicates that the null point is between 94° and 90°.

- 12) At this stage the product effect signal indicated on the bargraph display should be quite small. To obtain a more precise phase setting increase the sensitivity setting to give a larger signal indication on the bargraph display.
- 13) Now increase the phase setting in steps of 0.5° i.e. 90.5°, 91°, 91.5°, 92°, etc. until the product effect signal is reduced to a minimum and then just starts to increase again. Using the 0.1° digit adjust the phase setting up and down until minimum signal i.e. the null point is found.
- 14) Although not always necessary a more precise null point will be found by now using the 0.01° in a similar manner to the 0.1° digit as described in 13). Using the 0.01° digit adjust the phase setting up and down until minimum signal i.e. the null point is found.

The phase control circuit is now aligned to the product signal, next adjust the sensitivity so that the product signal gives a maximum signal of 3 to 4 green bars on bargraph display. If the sensitivity setting is less than 100 refer to note 1).

- 15) Check the susceptibility of the detector to vibration, if unacceptable (i.e. system vibration is showing on the bargraph) reduce the sensitivity until acceptable.

## OPERATING INSTRUCTIONS

- 16) Press the 'Enter' key to store the new settings in memory.
- 17) Test the sensitivity of the detector by passing metal samples through the aperture of the detector (preferably positioned on or placed in the product) and note the results.
- 18) If there are other product types to be inspected repeat this procedure from step 2).
- 19) Press 'PROG/EXIT' to return to the running mode.

### Notes

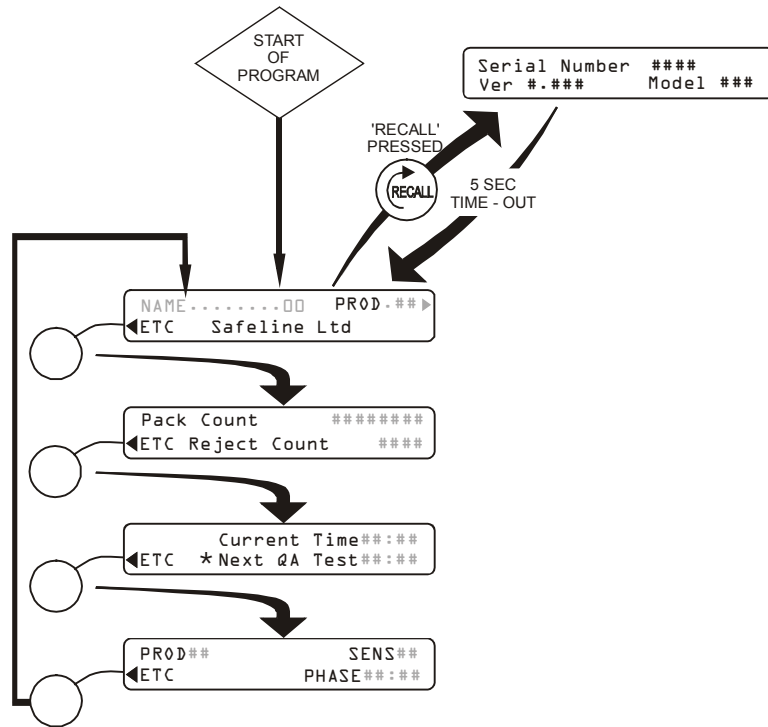
- 1) As a guide...If during manual setup the sensitivity is adjusted below 100, then improved spherical

performance may be achieved by switching 'Operating Frequency' to LOW and repeating the manual setup procedure, omitting step 4).

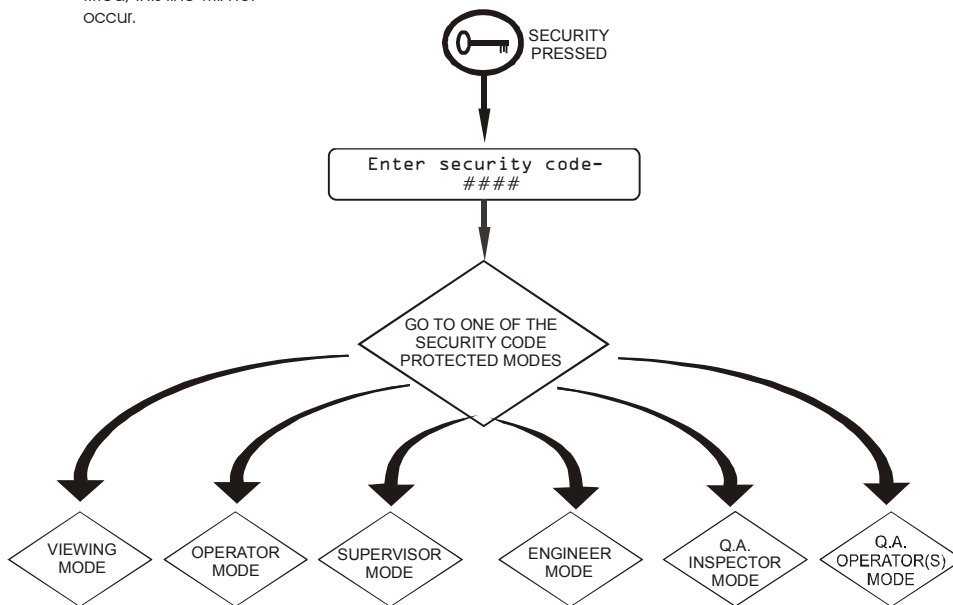
Under these conditions, to ensure that the best sensitivity is achieved, it is recommended that the manual setup procedure is carried out for both settings of 'Operating Frequency' (i.e. HIGH and LOW). A comparison should then be made between the two sets of results and the most favourable settings selected.

If during manual setup sensitivity is adjusted below 100 and 'Operating Frequency is already switched to LOW, then switch 'Power drive' to LOW and repeat the manual setup procedure, omitting step 4) and step 5).

# OPERATING INSTRUCTIONS



\*NOTE  
 If no QA test has been programmed to occur, or the QA option is not fitted, this line will not occur.



**Fig 12 Running Mode Flow Chart**

## RUNNING MODE



NOTE

Remember to record all settings on the Settings Sheets at the rear of the manual.

### Introduction

Please refer to Figure 12 for the complete sequence of displays in the Running Mode.

The Running Mode is the default mode of operation and the detector is automatically started in this mode after power on.

The display opposite is the first display of the Running Mode, and is the display that the detector returns to when any of the other operating modes are exited.

Press the Recall key to observe the following display.



### Serial Number, Version and Model



**IMPORTANT**

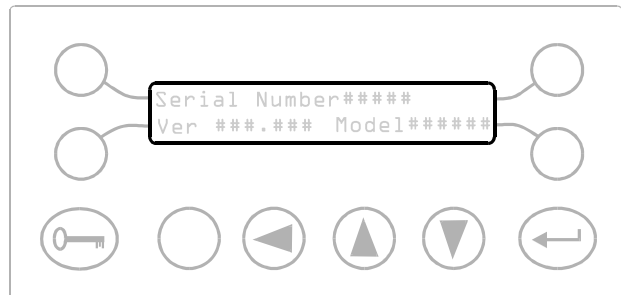
**The display opposite contains vital information that will always be requested when contacting Safeline. Make sure you have the above information to hand before telephoning.**

**Serial Number** - The serial number of your metal detector.

**Model #####** - The right-most number indicates the stagger frequency of your module. The next four numbers indicate the frequencies of operation your detector supports. The left-most number indicates the memory size fitted to your detector.

**Ver ###.##** - The software version of your metal detector.

After a period of 5 seconds the display will return to the display shown above. Pressing the soft key adjacent to ETC will change the display to the following.





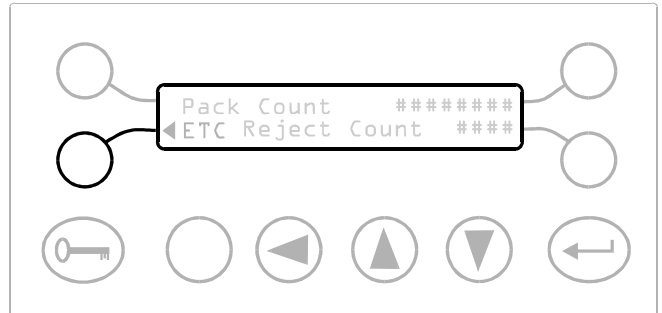
## Pack Count and Reject Count

### Pack count

This value shows the number of items that have passed through the detector. This count is increased each time the external pack sensor detects a product passing. It can be reset when in the Supervisor or Engineer modes.

### Reject count

This value shows the number of items that have been rejected. It can be reset when in the Supervisor or Engineer modes.



### Time

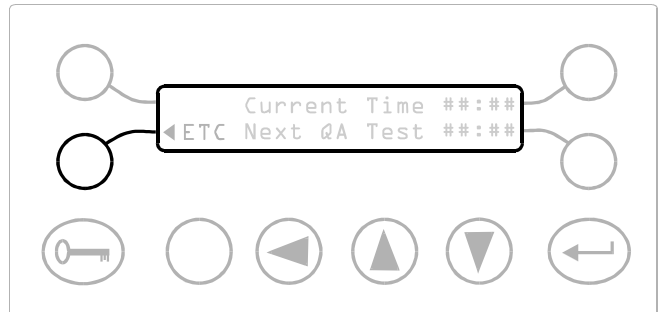
This display shows the current time and the time of the next QA test.

Refer to the Engineer Mode section for information on setting the current time.

Refer to the QA inspector section for information on setting the Next QA Test time.

### NOTE

If no QA test is programmed, or the QA option is not fitted, then 'Next QA test ###:##' will not appear.



### PROD.##

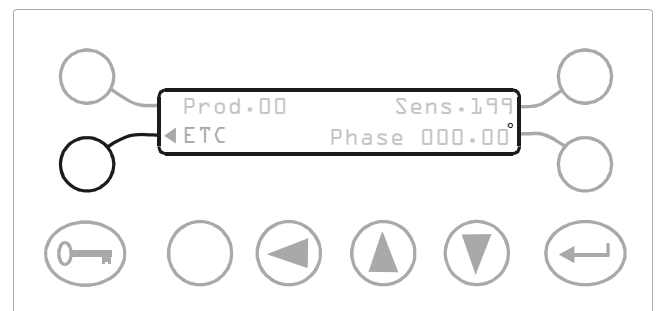
This display shows the current product.

### SENS.###

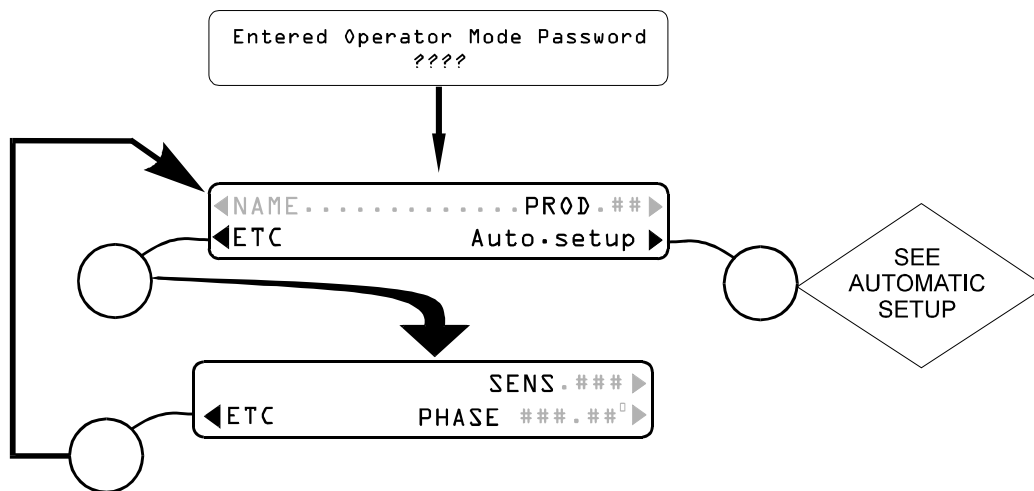
This display shows the current sensitivity.

### PHASE.###.##

This display shows the current phase.



# OPERATING INSTRUCTIONS



## NOTE

Auto.Setup feature and adjustment of sens and phase are only available if operator access is set to Full

Fig 13 Operator Mode Flow Chart

## OPERATOR MODE (Default security code = 0001)

### Introduction

Please refer to Figure 13 for the complete sequence of displays in the Operator mode.

The Operator mode is intended for personnel who require to operate the detector in a very limited way but who are prohibited from altering any settings vital to the detector operation.

The following items can be set when in the Operator mode.



NOTE

**Remember to record all settings on the Settings Sheets at the rear of the manual.**

### Product Number, Auto Setup and Name

#### AUTO SETUP



CAUTION

**Use of the Auto setup facility may alter settings previously set in other modes.**

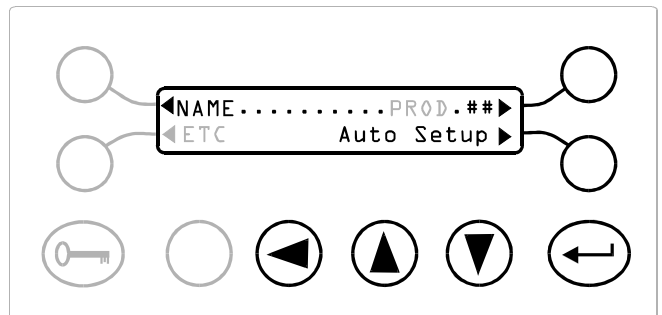
Press the soft key adjacent to Auto Setup to proceed to the Auto Setup sub-routine. Refer to the Auto Setup section for more information.

#### PROD ##

Press the soft key adjacent to PROD to select the product number the detector is to use or that you wish to set up. Use the cursor key and up and down keys to select a number between 00 and 20. Press the ENTER key when the correct Product Number is displayed.

#### NAME

Press the soft key adjacent to NAME to select the product by name. Press the ENTER key when the correct product name is showing.



#### NOTE

Auto.Setup feature is only available with operator access set to Full.

### Sensitivity and Phase

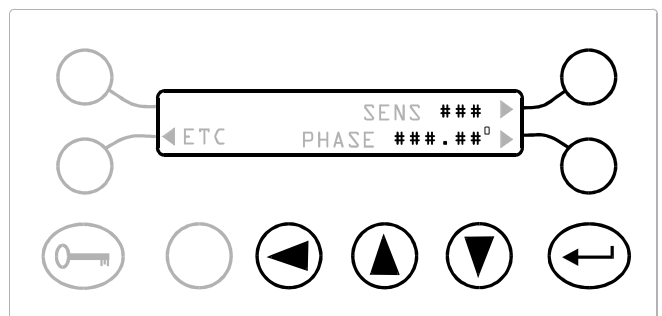
#### SENS

Press the soft key adjacent to SENS to change the Sensitivity value. Use the cursor key and up and down keys to select a value between 000 to 199. Press the ENTER key when the correct sensitivity is showing.

Note. At a sensitivity setting of 000 the metal detector will still be able to detect very large pieces of metal.

#### PHASE

Press the soft key adjacent to PHASE to change the phase value. Use the cursor key and up and down keys to select a value between 0.00° and 180.00°. Press the ENTER key when the correct phase is showing.



#### NOTE

This display is only available if operator access is set to Full

# OPERATING INSTRUCTIONS

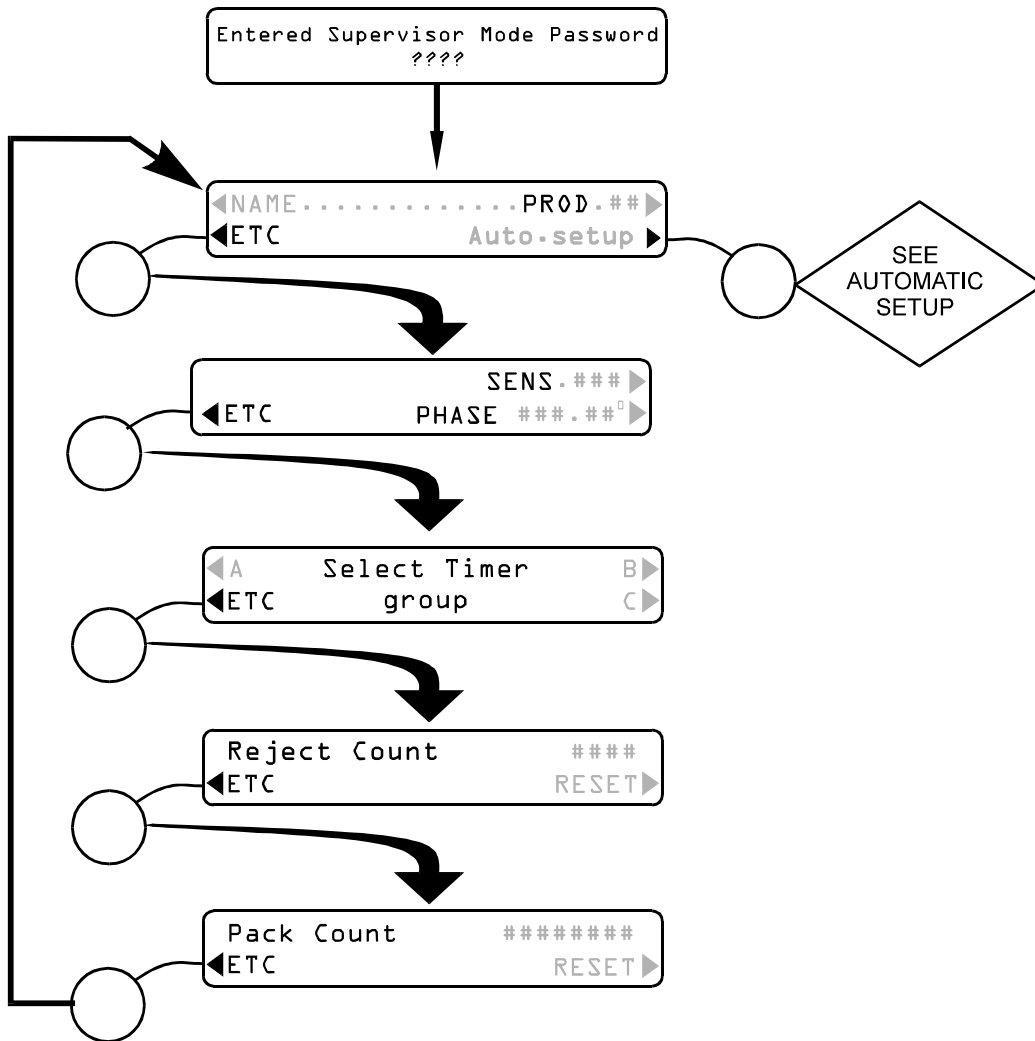


Fig 14 Supervisor Mode Flow Chart

## SUPERVISOR MODE (Default security code = 0002)

### Introduction

Please refer to Figure 14 for the complete sequence of displays in the Supervisor mode.

The Supervisor mode is intended for personnel who require to operate the detector in a very limited way but who are prohibited from altering any settings vital to the detector operation.

The following items can be set when in the Supervisors mode.



NOTE

**Remember to record all settings on the Settings Sheets at the rear of the manual.**

### Product Number, Auto Setup and Name

#### AUTO SETUP



CAUTION

**Use of the Auto setup facility may alter settings previously set in other modes.**

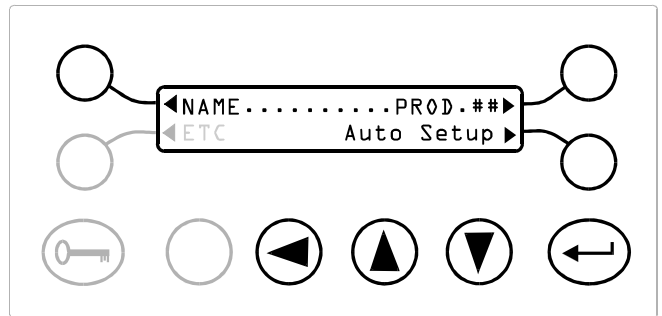
Press the soft key adjacent to Auto Setup to proceed to the Auto Setup sub-routine. Refer to the Auto Setup section for more information.

#### PROD ##

Press the soft key adjacent to PROD to select the product number the detector is to use or that you wish to set up. Use the cursor key and up and down keys to select a number between 00 and 20. Press the ENTER key when the correct Product Number is displayed.

#### NAME

Press the soft key adjacent to NAME to select the product by name. Press the ENTER key when the correct product name is showing.



### Sensitivity and Phase

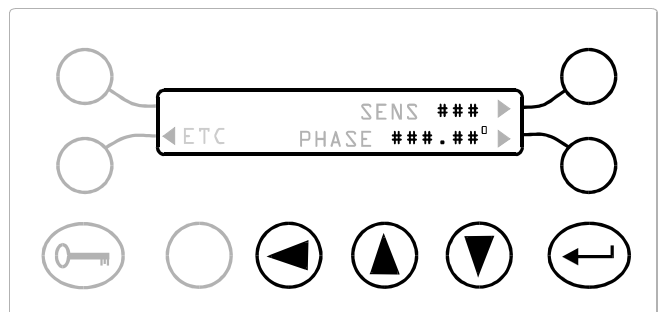
#### SENS

Press the soft key adjacent to SENS to change the Sensitivity value. Use the cursor key and up and down keys to select a value between 000 to 199. Press the ENTER key when the correct sensitivity is showing.

Note. At a sensitivity setting of 000 the metal detector will still be able to detect very large pieces of metal.

#### PHASE

Press the soft key adjacent to PHASE to change the phase value. Use the cursor key and up and down keys to select a value between 0.00° and 180.00°. Press the ENTER key when the correct phase is showing.



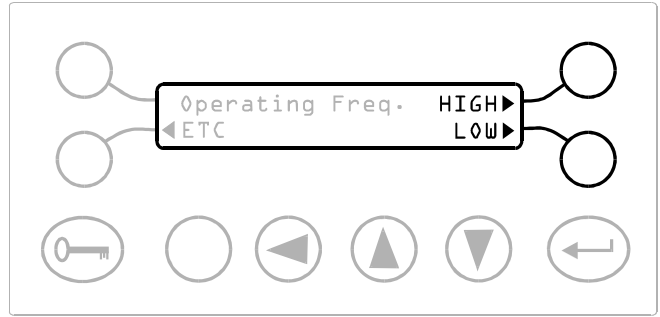
# OPERATING INSTRUCTIONS

## Operating Frequency

(Only available on Multi-frequency heads)

**HIGH** Select this soft key to cause the current product number to operate at the higher of the two frequencies.

**LOW** Select this soft key to cause the current product number to operate at the lower of the two frequencies.



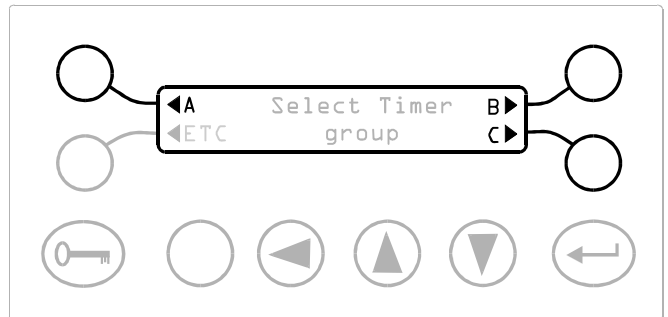
## Select Timer Group

Ensure you have read the 'Introduction to timers' in the features section of the manual, see page 3.

This display is used to select which timer group the current product number should use, (either timer group A, timer group B or timer group C).

The currently selected timer group for the current product number is indicated by a flashing cursor over the group letter.

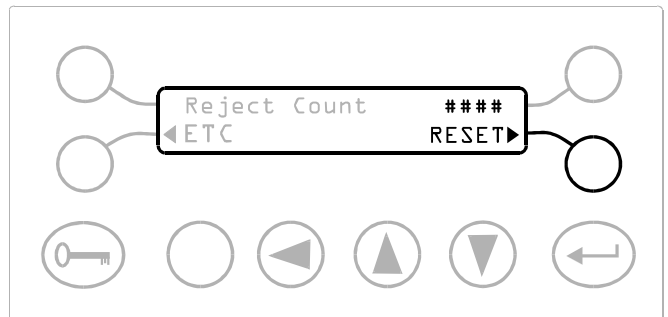
Press the soft key adjacent to the required group letter. The flashing cursor will appear over the selected group letter. When the cursor is indicating the intended group letter press the soft key adjacent to ETC to move to the next display.



## Reject Count

This display shows the number of reject relay operations. It does not show the number of detections or the number of rejects.

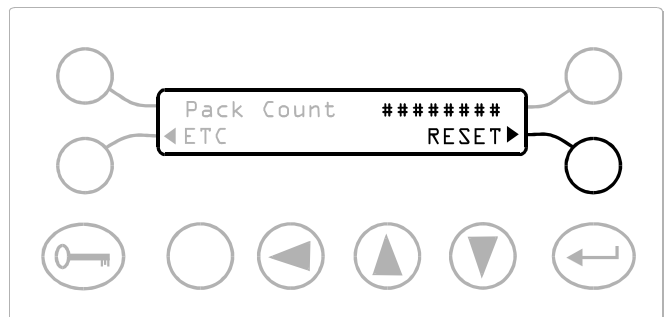
**RESET** - Press the soft key adjacent to RESET to zero the Reject Count value.



## Pack Count

This display shows the number of packs that have been checked by the detector.

**RESET** - Press the soft key adjacent to RESET to zero the Pack Count value.



# OPERATING INSTRUCTIONS

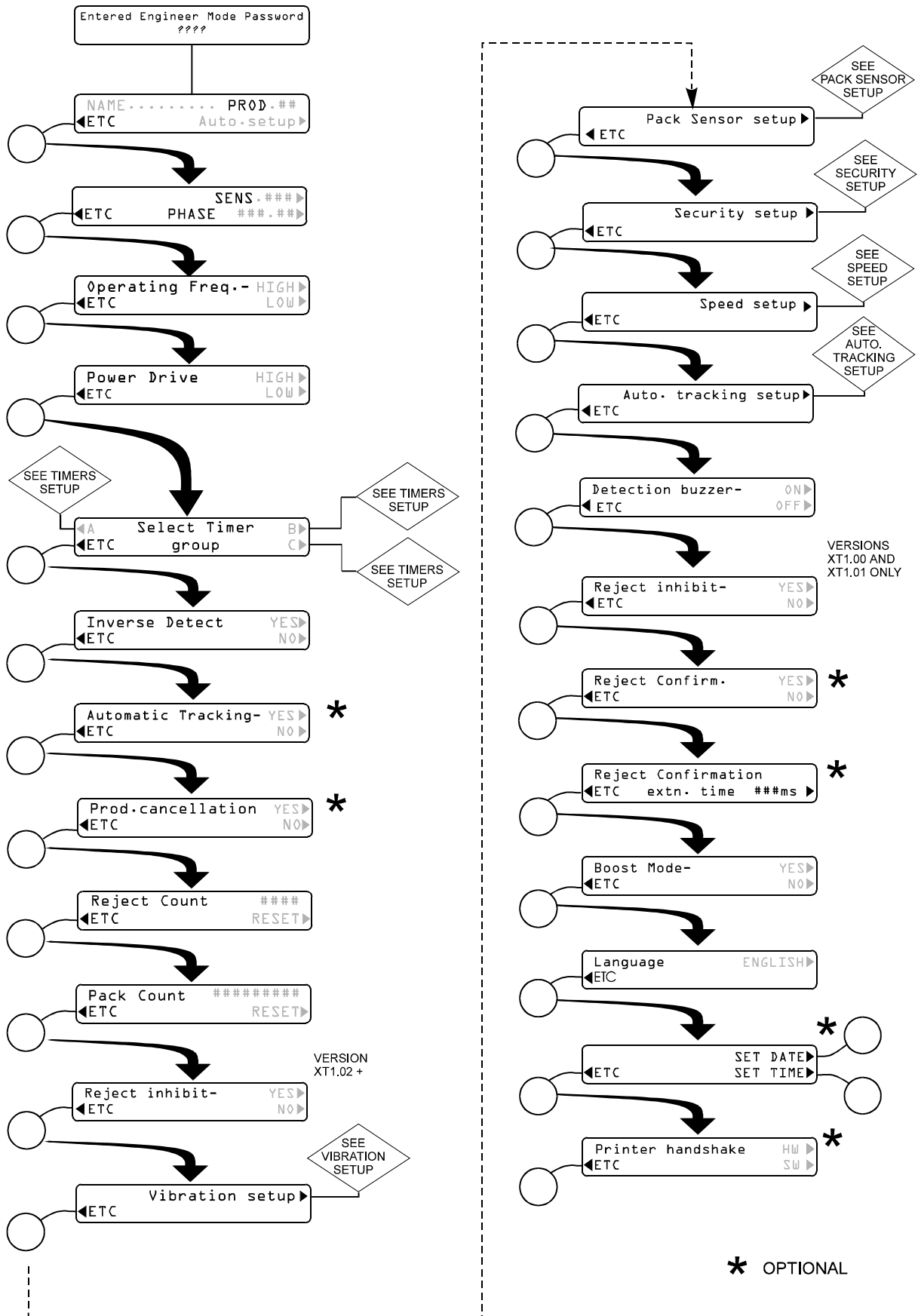


Fig 15 Engineer Mode Flow Chart

# OPERATING INSTRUCTIONS

## ENGINEER MODE (Default security code = 0003)

### Introduction

The Engineer's mode gives access to all variables and is used when first installing the metal detector or when making changes to setup characteristics.

Various operating characteristics of the detector are programmable and may be altered or configured to suit the particular requirements of the application.

The configuration process should be performed by the engineer when first installing the detector. The following items can be set when in the engineer's mode.



NOTE

**Remember to record all settings on the Settings Sheets at the rear of the manual.**

### Product Number, Auto Setup and Name

#### AUTO SETUP



CAUTION

**Use of the Auto setup facility may alter settings previously set in other modes.**

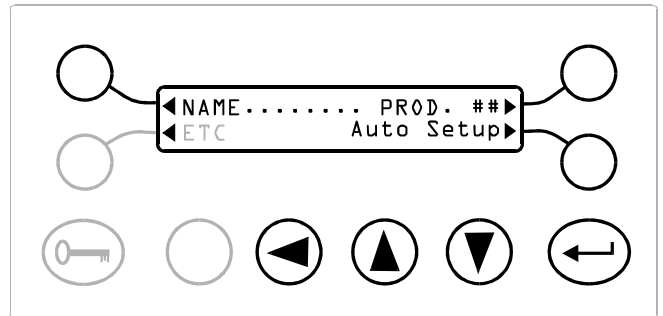
Press the soft key adjacent to Auto Setup to proceed to the Auto Setup sub-routine. Refer to the Auto Setup section for more information.

#### PROD ##

Press the soft key adjacent to PROD to select the product number to which the new settings will apply. Use the cursor key and up and down keys to select a number between 00 and 20. Press the ENTER key when the correct Product Number is displayed.

#### NAME

Press the soft key adjacent to NAME to edit the name or the current product number. Press the ENTER key when the correct name has been entered.



### Sensitivity and Phase

#### SENS

Press the soft key adjacent to SENS to change the Sensitivity value. Use the cursor key and up and down keys to select a value between 000 to 199. Press the ENTER key when the correct sensitivity is showing.

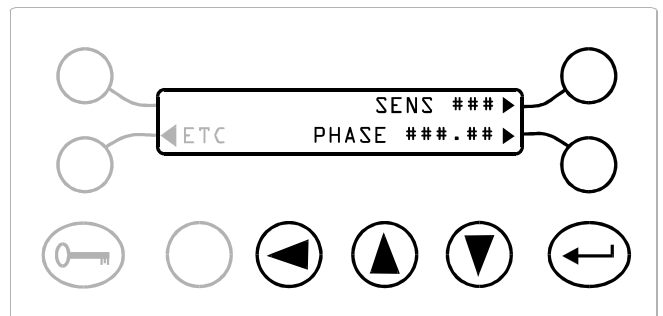
Note. At a sensitivity setting of 000 the metal detector will still be able to detect very large pieces of metal.

#### PHASE

Press the soft key adjacent to PHASE to change the phase value.

Use the cursor key and up and down keys to select a value between 0.00° and 180.00°.

Press the ENTER key when the correct phase is showing.





# OPERATING INSTRUCTIONS

## Operating Frequency

(Only available on Multi-frequency heads)

This facility allows the performance of the detector to be optimised for different product types, and is selectable for each product number. The choice of setting, HIGH or LOW, depends on the size of the product effect signal being produced by the product being inspected.

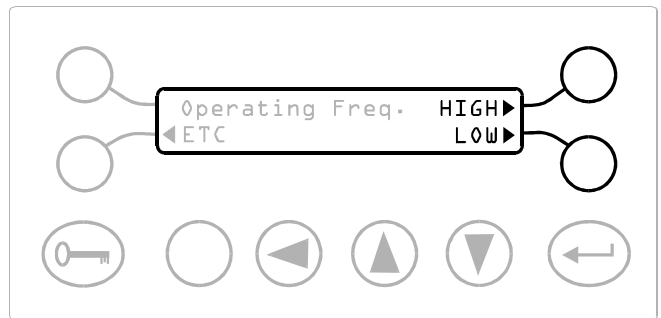
Generally speaking the HIGH setting will give improved spherical performance.

If the customer is not sure which setting to use for their product, then both settings should be tried and the setting which gives the best spherical sensitivity should be used.

If for a particular product this setting is changed it will be necessary to readjust the Phase and Sensitivity, this may be done automatically or manually.

**HIGH** press the soft key next to the HIGH display to select this setting for product with no or small product effect signal.

**LOW** press the soft key next to the LOW display to select this setting for product with large product effect signal.



---

## Power Drive

This feature allows the level of high frequency power being fed into the coil system to be changed, and is selectable for each product number.

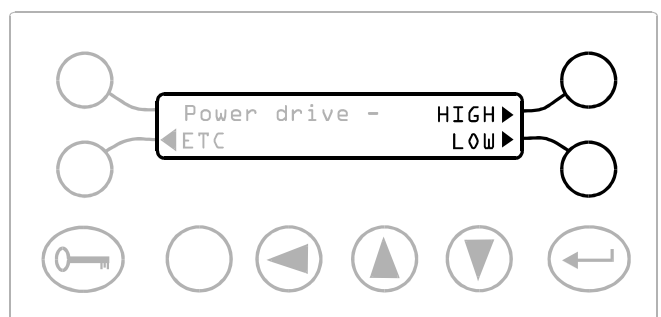
For a small number of applications, such as inverse detect, or where the product being inspected has a large product effect signal, it may be necessary to select the LOW power drive setting to reduce the sensitivity of the Detector.

For the majority of applications the HIGH power drive setting will be used.

If for a particular product this setting is changed it will be necessary to readjust the Phase and Sensitivity, this may be done automatically or manually.

**HIGH** Press the soft key next to HIGH to select the normal level of power drive.

**LOW** Press the soft key next to LOW to select the reduced value of power drive.



# OPERATING INSTRUCTIONS

## Select and Update Timer



CAUTION

Ensure you have read the sections on timers in the Features section of the manual (see page 3).

This display is used to either:

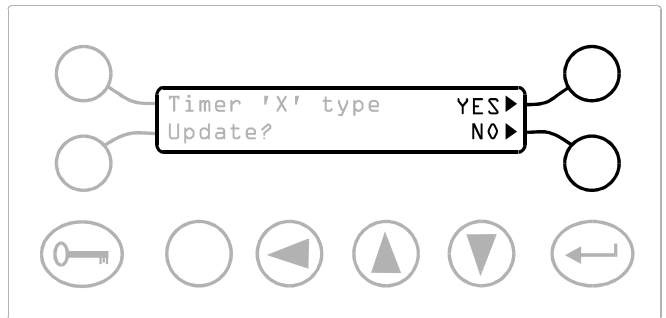
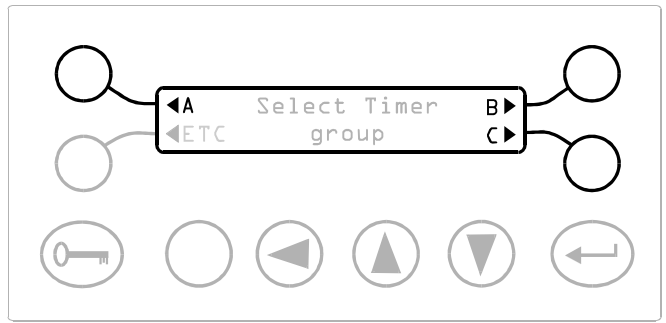
- 1) Select which timer group the current product number should use.

or

- 2) Select which timer group the current product number should use AND adjust the timer group settings such as timer type, delay time etc. The currently selected timer group will be indicated by a flashing cursor appearing over the group letter. Press the soft key adjacent to the group letter required. As soon as one of the three soft keys for the different groups is pressed the display opposite will appear.

If you are only intending to select the group to which the current product number will apply (number 1. above) then press the soft key adjacent to NO.

If you require to adjust the settings for the selected timer group then press the soft key adjacent to YES and refer immediately to the REJECT TIMERS section later in the manual.



## Inverse Detection

This feature allows the action of the reject timer to be reversed, such that the product containing no metal contamination is rejected whilst metal contaminated product is accepted.

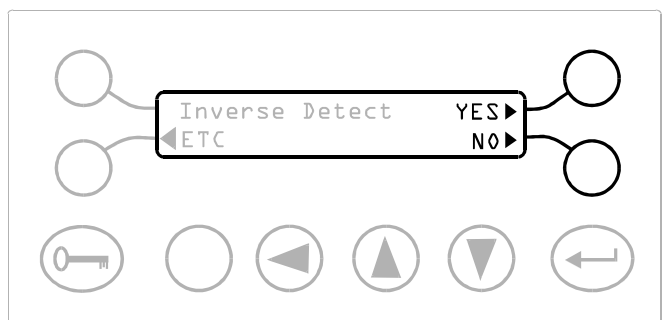
The feature is often used to verify that a product contains a metallic premium or free gift.

**YES** - YES to enable inverse detection for the current product number and reverse the action of the reject timer.

**NO** - Select NO to keep the reject timer in normal mode.

### Note:

This feature can only be selected when using a gated timer.



# OPERATING INSTRUCTIONS

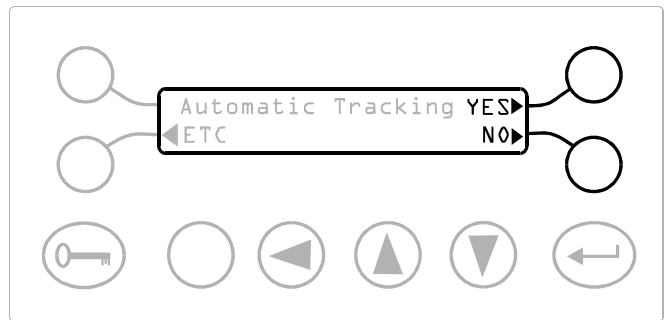
## Automatic Tracking (option)

Press the soft key adjacent to YES to enable Automatic tracking for the current product number.

Press the soft key adjacent to NO to disable Automatic Tracking for the current product number.

### Note:

*Enabling Automatic Tracking for a product number that has Product Signal Cancellation already enabled will cause the Product Signal Cancellation feature to be disabled for the product number*

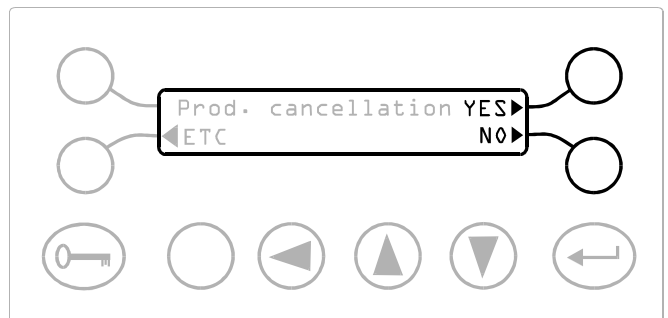


## Product Signal Cancellation (PSC) (option)

Press the soft key adjacent to YES to enable Product Signal Cancellation for the current product number. Press the soft key adjacent to NO to disable Product Signal Cancellation for the current product number.

### Note

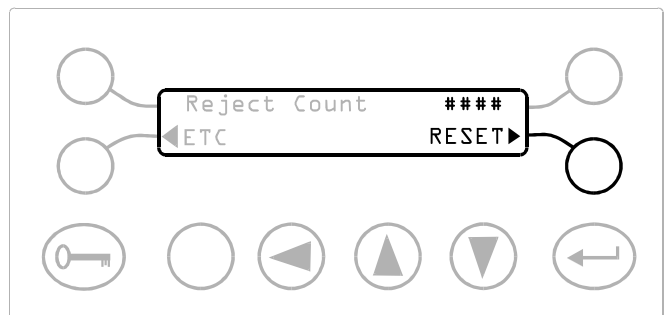
*Product signal cancellation must have been set up by the Auto Setup facility for the current product number before YES can be selected. Enabling Product Signal Cancellation for a product number that has the Automatic Tracking feature already enabled will cause the Automatic Tracking feature to be disabled for the product number.*



## Reject Count

This display shows the number of reject relay operations. It does not show the number of detections or the number of rejects.

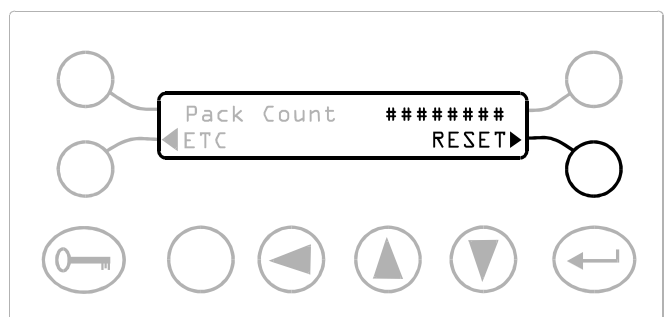
**RESET** - Press the soft key adjacent to RESET to zero the Reject Count value.



## Pack Count

This display shows the number of packs that have been checked by the detector.

**RESET** - Press the soft key adjacent to RESET to zero the Pack Count value.



# OPERATING INSTRUCTIONS

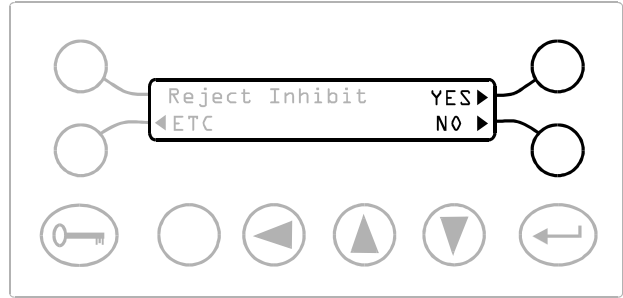
Reject inhibit (Version XT1.02 or Higher)



**DO NOT USE THIS FACILITY TO INHIBIT THE REJECT DEVICE DURING MAINTENANCE WORK. ALWAYS REMOVE THE POWER SUPPLY TO THE REJECT DEVICE BEFORE MAINTENANCE WORK IS STARTED.**

**YES** - Select YES to override the operation of the reject device during setting up operations.

**NO** - Select NO for normal use

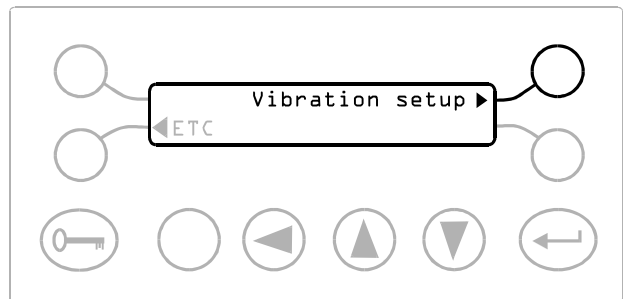


---

## Vibration setup

Press the soft key adjacent to Vibration setup to enter the Vibration Setup menu.

Refer to the Vibration Setup section for more information.

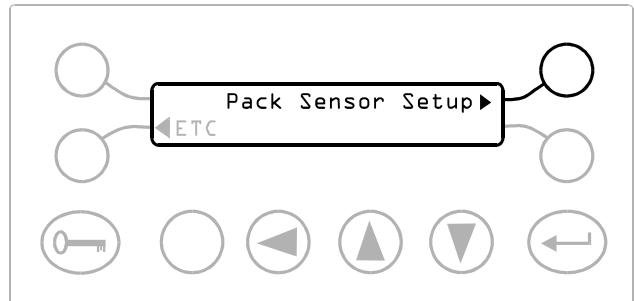


---

## Pack Sensor Setup

Press the soft key adjacent to Pack Sensor Setup to enter the Pack sensor menu.

Refer to the Pack Sensor section for more information.



---

## Security Setup

Press the soft key adjacent to Security Setup to enter the Security setup menu.

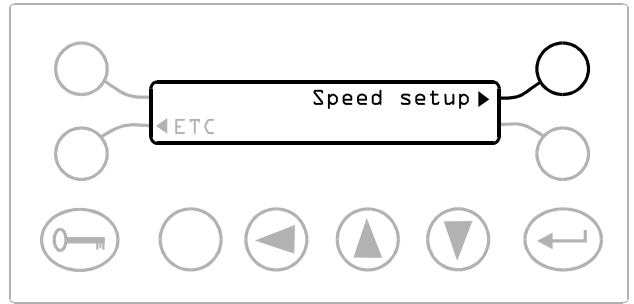
Refer to the Security Setup section for more information.



## Speed setup

Press the soft key adjacent to Speed setup to enter the Speed setup menu.

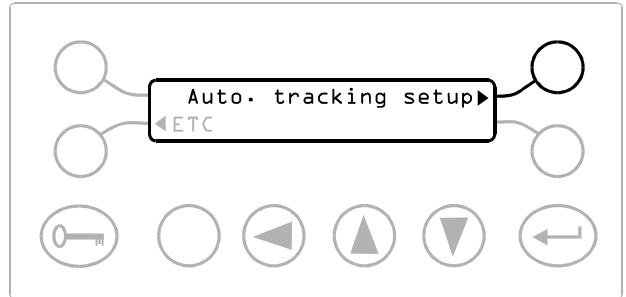
Refer to the Speed setup section for more information.



## Auto. tracking setup

Press the soft key adjacent to Auto. tracking setup to enter the Auto. tracking setup menu.

Refer to the Auto. tracking setup section for more information.



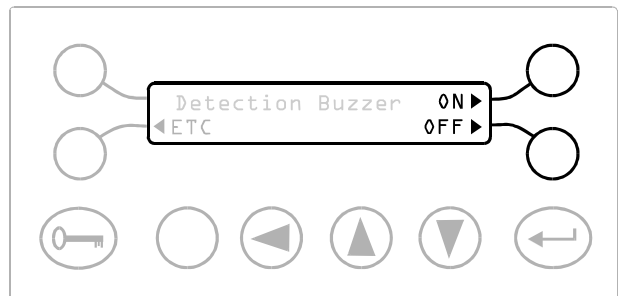
## Detection Buzzer

**ON** - Select ON so that the buzzer will sound when metal is detected.

**OFF** - Select OFF to prevent the buzzer sounding when metal is detected.

Note:

The buzzer will always sound if a key is pressed or a fault occurs irrespective of the setting here.



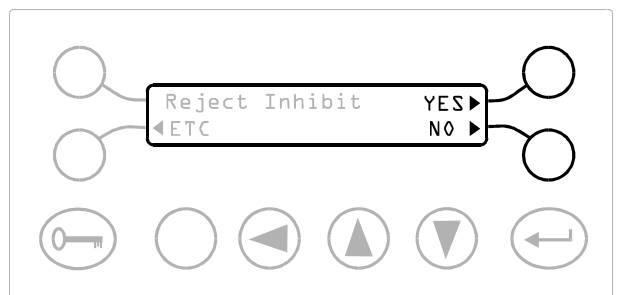
## Reject inhibit (Versions XT1.00 and XT1.01 only)



**DO NOT USE THIS FACILITY TO INHIBIT THE REJECT DEVICE DURING MAINTENANCE WORK. ALWAYS REMOVE THE POWER SUPPLY TO THE REJECT DEVICE BEFORE MAINTENANCE WORK IS STARTED.**

**YES** - Select YES to override the operation of the reject device during setting up operations.

**NO** - Select NO for normal use



# OPERATING INSTRUCTIONS

## Reject Confirmation (Option)

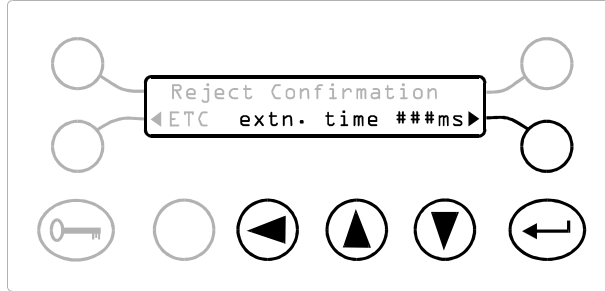
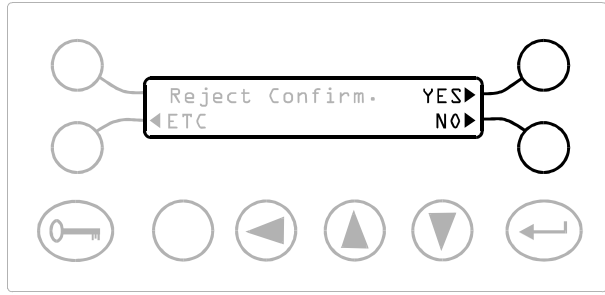
The optional Reject Confirmation Unit (RCU) confirms that the reject mechanism has operated at the correct time.

**YES** - Select YES if you require Reject Confirmation

**NO** - Select NO if the Reject Confirmation is not required.

**EXTN. TIME** - This is the time taken for the external sensor to detect that a contaminated package has been rejected.

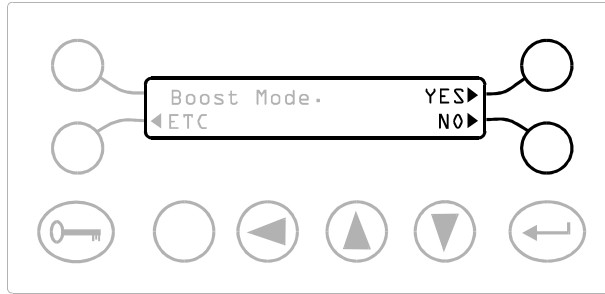
Note. This display will only appear if YES is selected on the display above. For timer types tm3 and tm3G the extn. time is not used and window time is used.



## Boost Mode

**YES** - Select YES to improve the sensitivity by 20% at a sensitivity of 199.

**NO** - Select NO for normal sensitivity at 199.



## Language

**LANGUAGE** - Use the soft key to scroll through the languages (including English). The languages available are:

- English
- French
- Italian
- Spanish
- German
- Dutch
- Danish
- Swedish
- Japanese
- Polish



# OPERATING INSTRUCTIONS

## Set Date and Time (Option)

**SET DATE** - Press the soft key adjacent to SET DATE to proceed to the SET DATE display

**SET TIME** - Press the soft key adjacent to SET TIME to proceed to the SET TIME display.

**YEAR** - Press the soft key adjacent to YEAR to adjust the year value. Use the cursor key and up and down keys to select the correct year. Press the ENTER key when the correct year is set.

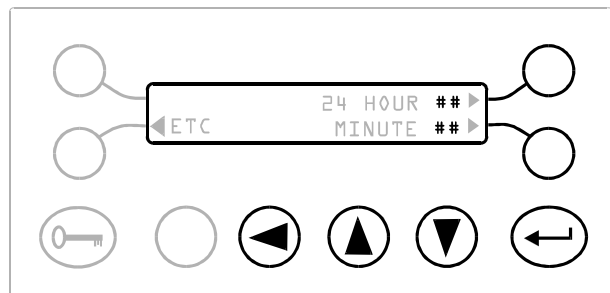
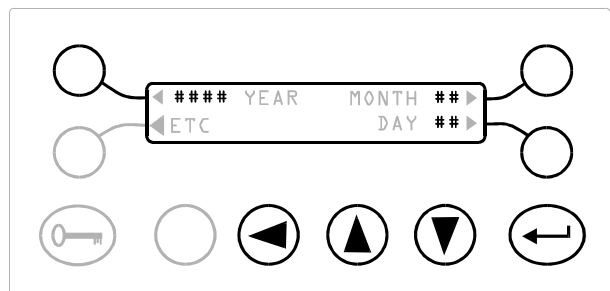
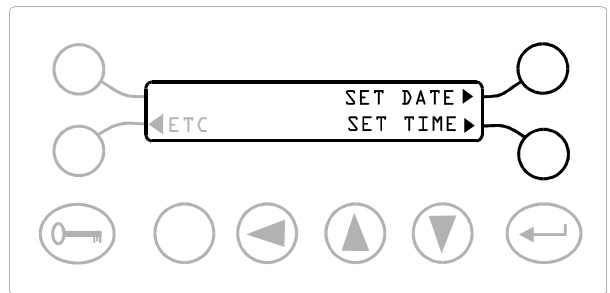
**MONTH** - Press the soft key adjacent to MONTH to adjust the month value. Use the cursor key and up and down keys to select the correct month. Press the ENTER key when the correct month is set.

**DAY** - Press the soft key adjacent to DAY to adjust the day value. Use the cursor key and up and down keys to select the correct day. Press the ENTER key when the correct day is set.

**24 HOUR** - Press the soft key adjacent to 24 HOUR to adjust the hour value of the current time. Use the cursor key and up and down keys to select the correct hour. Press the ENTER key when the correct hour is set.

The clock uses the 24 hour format.

**MINUTE** - Press the soft key adjacent to MINUTE to adjust the minute value of the current time. Use the cursor key and up and down keys to select the correct minute value. Press the ENTER key when the correct minute is set.



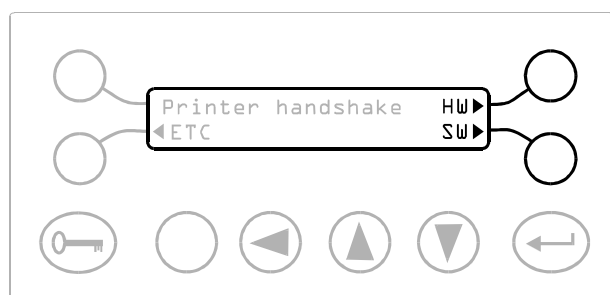
## Printer Handshake (Option)

This display controls the handshaking mode that the electronic module uses with a dedicated printer.

**HW** - Press the soft key adjacent to HW if a hardware handshake is required. This is the default setting.

**SW** - Press the soft key adjacent to SW if a software handshake is required. If this option is selected the detector uses X-ON X-OFF flow control.

Refer to Appendix B for more information



## AUTOMATIC SETUP

### Introduction

The automatic setup feature may be used to automatically set the following;

- Sensitivity
- Phase
- Frequency (see Note below)
- Product Signal Cancellation

The automatic setup feature is designed to make setting up your metal detector as easy as possible by requesting the operator to pass the product through the aperture at specific times and NOT requiring the operator to adjust any of the controls.

Before using the automatic setup feature ensure that

- a) If a pack sensor is fitted that the pack sensor has been set up correctly.
- b) That the speed of the product has been set-up correctly.
- c) The sensitivity limit has been set correctly.
- d) If the application is an 'Inverse detect' application that the 'Inverse detect' feature has been enabled before starting automatic setup.

The automatic setup feature can NOT be used to set up for products on a continuously running product line.

The automatic setup feature will correctly set up for products that exhibit or do not exhibit a product effect.

Normally the operator will have to pass the product through the aperture about four times (see the section below entitled "Notes on passing product through the detector" At worst the operator will be requested to pass the product through the aperture ten times.

If a pack sensor is to be used with the detector, set up the pack sensor details before starting automatic setup - for certain products the use of the pack sensor will speed up the operation of automatic setup.

The automatic setup supports 'Inverse detect' applications. If required select the 'Inverse detect' feature ON for the current product number prior to starting automatic setup.

### Note

- 1) Automatic setup will attempt to setup the detector in the currently selected Operating Frequency setting. However there are two conditions where automatic setup will change the currently selected 'Operating Frequency' setting, these are;
  - a) If 'Operating Frequency' is set to HIGH, automatic setup will change this to LOW under large product signal conditions.
  - b) If 'Operating Frequency' is set to LOW, automatic setup will change this to HIGH under dry or very small product signal conditions.



NOTE

In a minority of cases following automatic setup it may be necessary to manually trim the phase and/or sensitivity to optimise performance. Refer to the earlier Sensitivity and Phase display for details on how to do this.



NOTE

**Remember to record all settings on the Settings Sheets at the rear of the manual.**



## Notes On Passing Product Through the Detector



NOTE

The product should be continually moving, the detector will not operate with standing/stationary product in the aperture.

To ensure that the detector is set up correctly and will operate satisfactorily during normal production, we recommend that the product used for automatic set up is passed through the detector in the worst case position and orientation which would occur during normal production.

The worst case product effect condition is when the greatest disturbance of the coil system/largest product signal is experienced. This occurs when the coil system condition changes from no product to maximum product.

With individual or boxed/cartoned product the worst case product effect condition occurs as the product enters and leaves the detector. If the product is rectangular the product effect signal will generally be more severe if the product enters the detector aperture long edge leading, as opposed to short edge leading. The gaps between the products will create the worst case product effect condition. If successive products are touching a reduced product signal will result.

For the majority of product types the worst case condition occurs the closer the product is to the faces of the detector aperture.

The technique of setting up to the worst case product effect condition will ensure that no false product rejections occur during normal running conditions.

# OPERATING INSTRUCTIONS

## Product Signal Cancellation



NOTE

This feature will only be helpful in a minority of applications where the product characteristics and presentation produce a consistent product effect signal

Phasing out a product effect signal whether manually or automatically very often does not eliminate the product signal entirely. The remaining signal normally means that the sensitivity of the detector must be reduced to eliminate the product signal entirely, and this in turn leads to reduced performance. Product signal cancellation aims to eliminate any remaining product effect signal without the need for running at reduced sensitivity.

PSC may only be used on certain applications that fall within the following guidelines;

- The product has to be discrete, not continuous.
- The products must be similar in constituency and size.
- The products must be on a constant speed line (minimum speed 10 m/min).

- A pack sensor must be used, (mounted as close to the detector as possible).
- The products must pass through the detector with consistent orientation and position.
- The products must be setup using the detectors automatic setup facility.
- The maximum value of sensitivity is not already being used without PSC.
- The products must have a maximum pack length of 1m.
- Sufficient space between successive packs for the pack sensor to be able to distinguish individual packs.

PSC can NOT be used if any of the following circumstances are present;

- The product is loose or has a variable constituency.
- The system is a pipe line, gravity feed, or variable speed system.
- The products presentation cannot be guaranteed to be consistent.
- More than five products packs may be influencing the metal detector at the same time.

## Carrying Out Automatic Setup

The operator is not required to take any action for most of the displays other than to pass the product when instructed.

- (1) Ensure that the conveyor is running.
- (2) Ensure **no** product is passing through the detector.

When this display is showing, pass the product through the aperture in its normal manner to create a worst case product effect signal, for more details refer to 'Notes On Passing Product Through The Detector' earlier.

If the detector does not detect any product being passed within a thirty second period, the unit will revert back to the display from which automatic setup was started.

- (3) Select a sample product.
- (4) Select auto-setup and follow the displayed instructions. Most of the displays will require no operator interaction. The exceptions to this rule are shown below.



# OPERATING INSTRUCTIONS

If product signal cancellation is required for the current product number select YES, else select NO.



This display appears when automatic setup has finished. The display will be seen for a few seconds, and then will revert back to the display from which automatic setup was started.

Passing the product through the aperture should now give 2 to 4 segments on the bar graph display.



NOTE

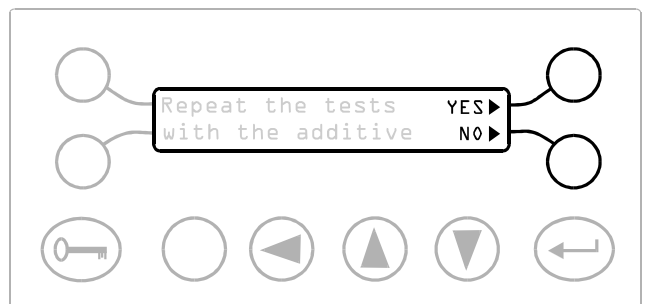
In a minority of applications it may be necessary to manually trim the phase and/or sensitivity to optimise performance. If this is required refer to the 'How to Manually Trim The Phase And/Or Sensitivity' later in this section.

Test the sensitivity of the detector by passing metal samples through the aperture of the detector (preferably on or in the product).

If required manually adjust Sensitivity (page 53) to achieve the required spherical performance standard, i.e. 1.0, 1.5, 2.0 Fe, etc.

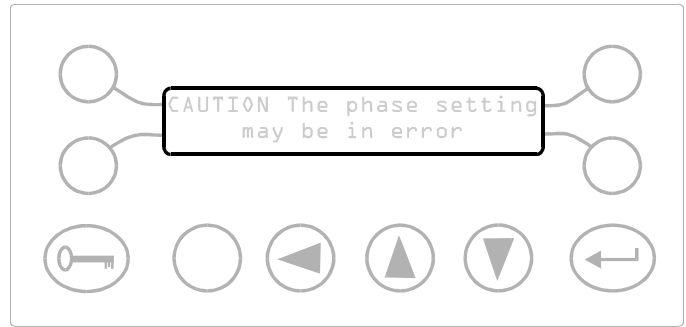
Note the sensitivity level for the bargraph may be limited by the vibration characteristics of the system. If this is the case then ensure that manually increasing the sensitivity does not cause the detector to trigger from system vibration.

This display occurs if automatic setup is being performed on a product number with the inverse detect feature enabled. Selecting YES allows the calibration of the product and additive combination to be performed again. This allows different orientations of the additive to be tested - the automatic setup will always choose the best setting out of all of the orientations tried. When there are no more orientations to be tried select NO.

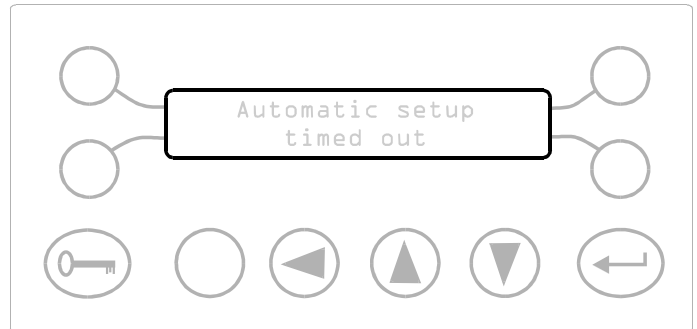


# OPERATING INSTRUCTIONS

This display will occur if the electrical signal produced by the product passing through the aperture was insufficient to guarantee the accuracy of the setting of the phase control.

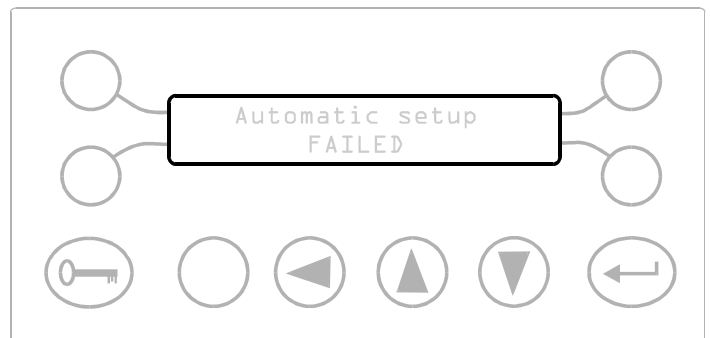


This display will occur if no product was passed through the detector when requested.



This display may occur for one of the following reasons.

- 1) The detector is sensing a signal when there should be no product passing through the aperture.  
*Repeat the automatic setup and ensure that no product is passed through the detector when instructed, and that no product or metal is close to the aperture and influencing the detector.*
- 2) The automatic setup has requested the user to 'Pass product through aperture ....' and no product has been sensed within the required period.  
*Repeat the automatic setup and ensure that the product is passed through the aperture when requested.*
- 3) The automatic setup has not been able to setup correctly due to the size of the product signal.  
*Switch 'Power drive' to LOW (page 45) and repeat the automatic setup.*



## How to Manually Trim The Phase and/or Sensitivity

The objective of the following procedure is to ensure the setting of phase and sensitivity are optimised following automatic setup.

The correct setting of the phase will be one value which will give minimum signal from the product on the bargraph display, this is known as the "null point" setting. Changing the phase setting up or down in value from this setting will increase the amplitude of the signal.

The correct setting of the sensitivity will be a value which gives a peak signal from the product of 3 to 4 bars on the LED bargraph display.

- 1) Pass the product through the aperture in its normal manner to create a worst case product effect signal, for more details refer to 'Notes On Passing Product Through The Detector'.
- 2) If required adjust the sensitivity so that the peak signal from the product gives 3 to 4 bars on the LED bargraph display. Press the 'Enter' key to store the new setting in memory.
- 3) Adjust the sensitivity so that the peak signal from the product gives a reading on the LED bargraph display of approximately half full scale (i.e. 10 green bars), refer to note 1).
- 4) To verify/optimize the "null point" set by the automatic setup, increase the phase setting in steps of  $1^\circ$  and at each step observe if the amplitude of product signal indicated on the bargraph display reduces. If an increase in product signal is observed, then decrease the phase setting in steps of  $1^\circ$  and at each step observe if the amplitude of product signal indicated on the bargraph display reduces.

For example if the automatic setup value is  $90^\circ$ , and as the phase setting is increased there is a clear reduction in signal as we change from  $90^\circ$  to  $91^\circ$ , and then from  $91^\circ$  to  $92^\circ$  the signal starts to increase again, this indicates that the "null point" is between  $90^\circ$  and  $92^\circ$ .

- 5) Now reduce the phase setting in steps of  $0.2^\circ$  i.e.  $91.8^\circ$ ,  $91.6^\circ$ ,  $91.4^\circ$ ,  $91.2^\circ$ , etc. until the product effect signal is reduced to a minimum and then just starts to increase again.

For example, if as the setting is reduced there is clear reduction in signal from  $90.8^\circ$  to  $90.6^\circ$ , and then from  $90.6^\circ$  to  $90.4^\circ$  the signal starts to increase again, this indicates that the "null point" is between  $90.8^\circ$  and  $90.4^\circ$ . Using the  $0.1^\circ$  digit adjust the phase setting up and down until minimum signal i.e. the "null point" is found.

- 6) Although not always necessary a more precise "null point" will be found by now using the  $0.01^\circ$  in a similar manner to the  $0.1^\circ$  digit as described in 5).

The phase control circuit is now aligned to the product signal, next adjust the sensitivity so that the product signal gives a maximum signal of 3 to 4 green bars on bargraph display, refer to Note.

- 7) Check the susceptibility of the detector to vibration, if unacceptable (i.e. system vibration is showing on the bargraph) reduce the sensitivity until acceptable.
- 8) Press the 'Enter' key to store the new settings in memory.

### Note

When using the phase control to minimise product signals the detector may become more susceptible to vibration. The final setting of the sensitivity may be limited by vibration effects rather than product effect.

# OPERATING INSTRUCTIONS

## VIBRATION SETUP

### Introduction

This menu is used to set-up the detector for optimum performance with any vibration present in the system.

#### NOTE

When adjusting the sensitivity limit ensure that all mechanical and electronic equipment that may be a source of vibration is operating (including reject devices etc.).



NOTE

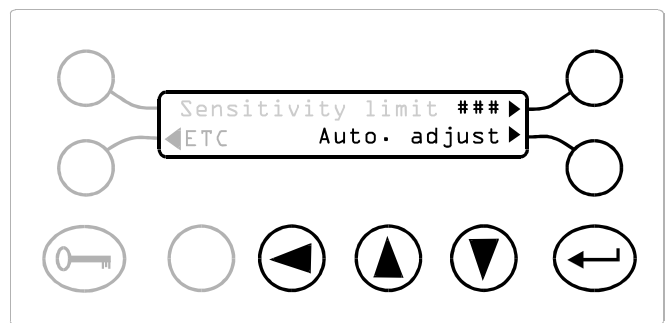
**Remember to record all settings on the Settings Sheets at the rear of the manual.**

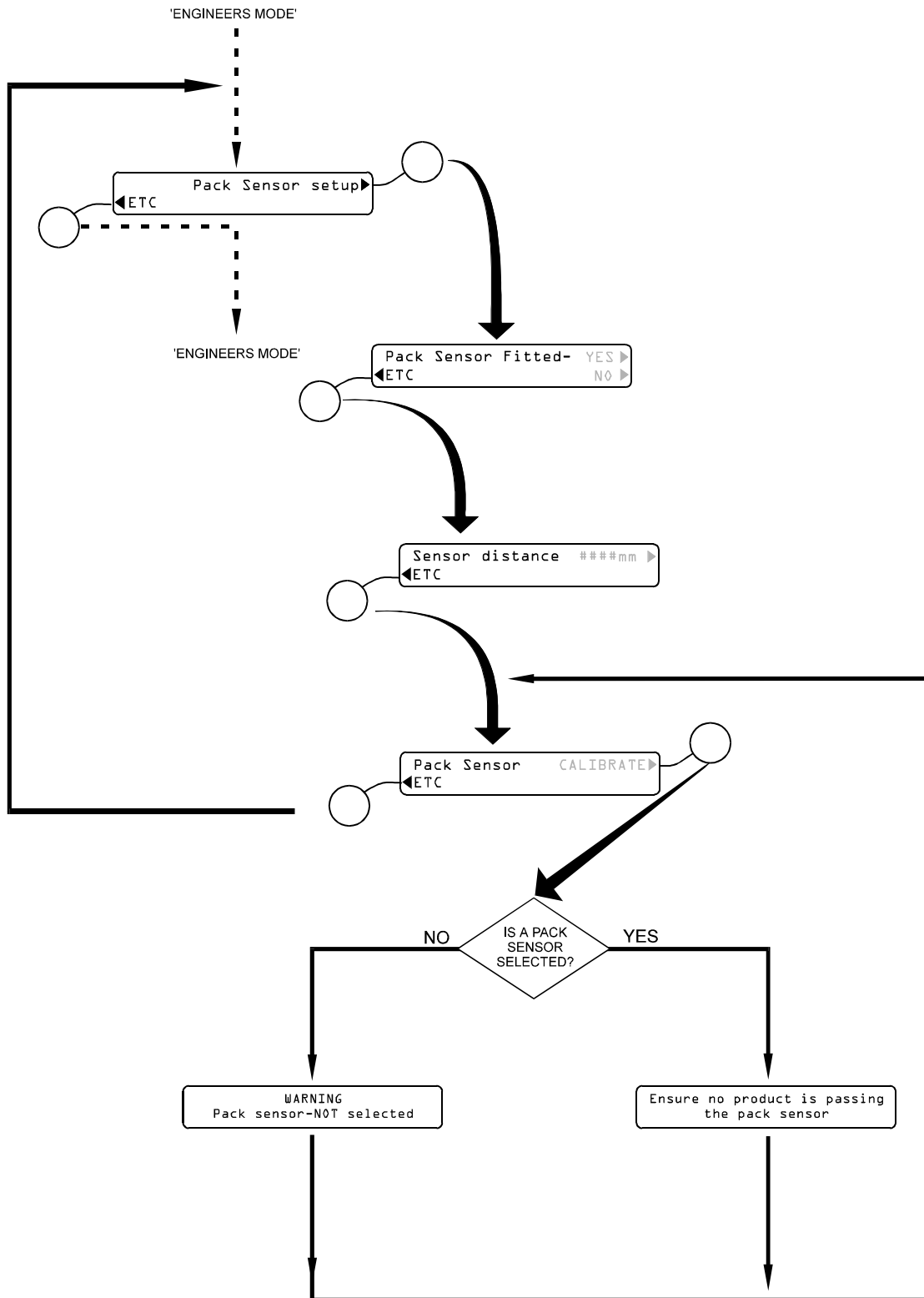
### Sensitivity limit

This display is used to manually or automatically set-up the maximum sensitivity that will be set by the automatic setup feature of the detector. The maximum sensitivity must be reduced in situations where the detector is subject to high vibration.

Press the soft key adjacent to sensitivity limit to manually set the sensitivity limit. Press the ENTER key when finished.

Press the soft key adjacent to Auto. Adjust to automatically set the sensitivity limit.





**Fig 16 Pack Sensor Mode Flow Chart**

# OPERATING INSTRUCTIONS

## PACK SENSOR SETUP

### Introduction

This facility provides automatic calibration of the pack sensor if installed.

For connection information and physical characteristics of the pack sensor input see Technical Specification and connection details.

### Gating

Timers tm2 and tm3 may be gated, however an external sensor is required to sense the position of the product/pack when used in the gated mode.

Photogated reject timers provide very precise and effective reject operations. For example, if a pusher reject is used to reject boxed product, photogating ensures that the pusher hits the pack in the same position every time. Without photogating the rejecting operation would be dependent upon the position of the metal contaminant in the pack and hence be more variable in operation.



NOTE

**Remember to record all settings on the Settings Sheets at the rear of the manual.**

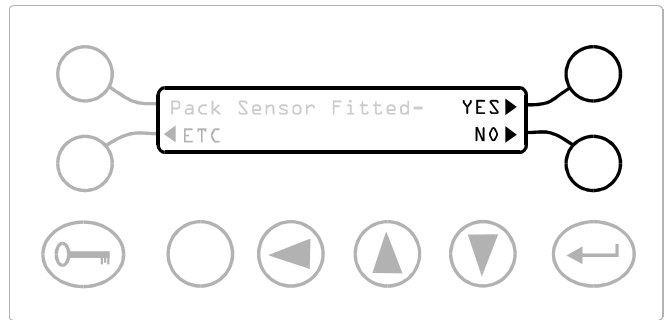
### Pack Sensor Fitted

Carry out the following procedure to automatically calibrate the pack sensor:

**YES** - Press the soft key adjacent to YES if a pack sensor is fitted.

**NO** - Press the soft key adjacent to NO if there is no sensor fitted.

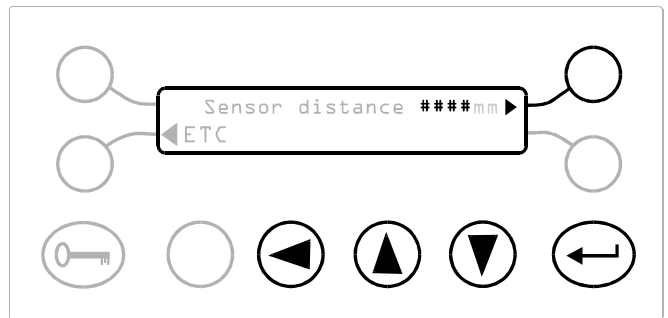
Press the soft key adjacent to ETC to move to the next display.



### Sensor distance

This is the distance between the centre of the pack sensor and the infeed face of the detector.

Press the soft key adjacent to #####mm to change the value of sensor distance. This distance should be entered in mm (inches for U.S. version)



*U.S. version*



# OPERATING INSTRUCTIONS

## Pack Sensor Calibration

Press the soft key adjacent to CALIBRATE to start the automatic calibration of the sensor.

When the CALIBRATE soft key has been pressed one of two displays will appear, for a short time

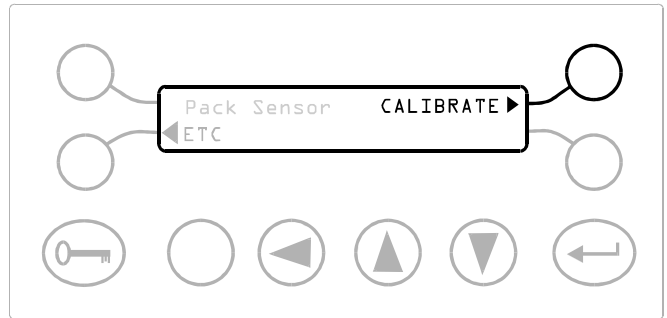
- a) If the display opposite appears you will be returned to the previous display and the sensor will not be calibrated.

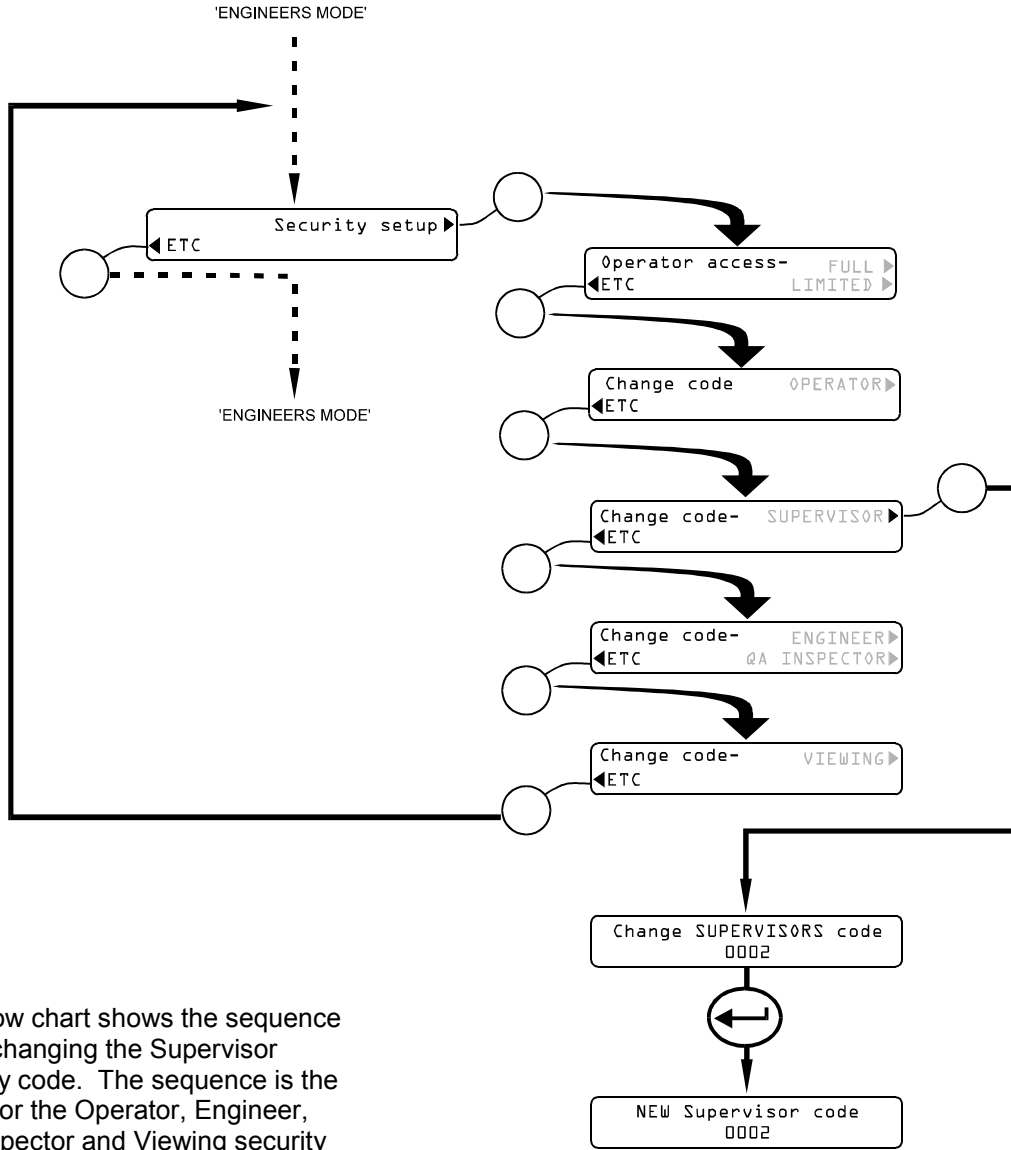
This message will appear if NO was selected on the previous display.

or

If 'Ensure no product is passing the pack sensor' appears the calibration will proceed.

- b) After a short time the display will return to the 'Pack Sensor Calibrate' display shown above. Press ETC to return to the Engineer Mode.





**NOTE**  
 This flow chart shows the sequence when changing the Supervisor security code. The sequence is the same for the Operator, Engineer, QA Inspector and Viewing security codes.

**Fig 17 Security Setup Flow Chart**

# OPERATING INSTRUCTIONS

## SECURITY SETUP

### Introduction

At Safeline metal detectors are shipped from the factory with the following security codes pre-programmed.

|           |   |                   |
|-----------|---|-------------------|
| Code 0001 | = | Operator mode     |
| Code 0002 | = | Supervisor mode   |
| Code 0003 | = | Engineer mode     |
| Code 0004 | = | QA Inspector mode |
| Code 0005 | = | Viewing mode      |

The Security Setup sub-routine allows the changing of the security codes for up to four of the operating modes (i.e. Supervisor, Engineer, QA Inspector and Viewing). The Security Setup sub-routine can only be accessed from the Engineer Mode.



**Take care to memorise your new security codes.**

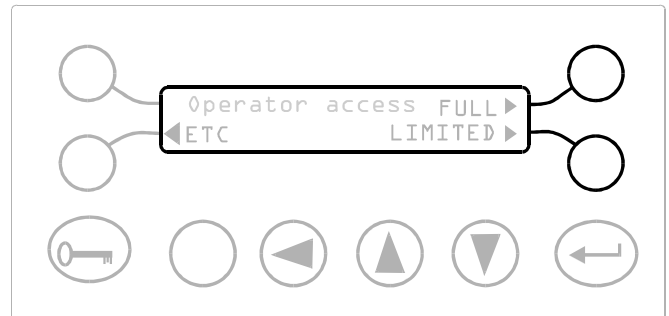
---

### Operator access

This display enables the detector to operate such that by entering the OPERATOR security code it is possible to change the sensitivity and phase of a product as well as just changing the product number.

**LIMITED** Press the soft key next to LIMITED to prevent any person with an OPERATOR security code from being able to alter phase and sensitivity.

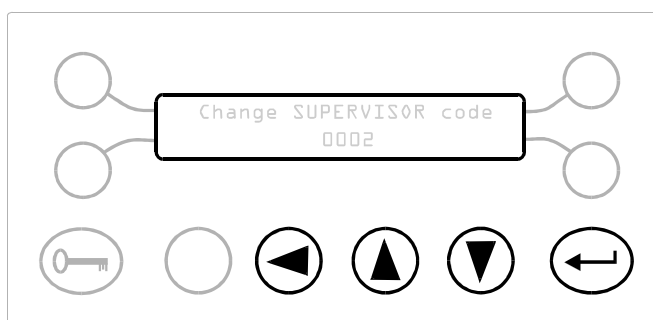
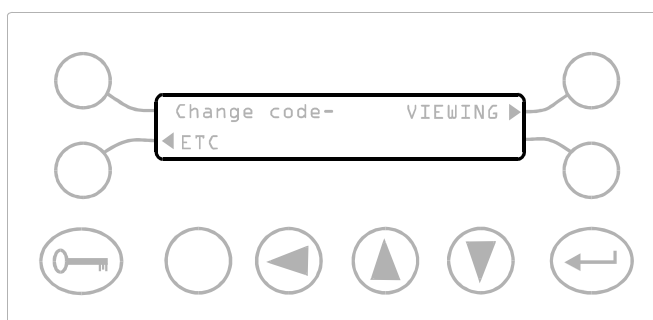
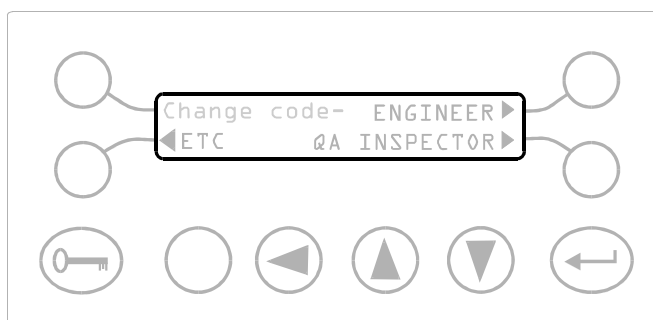
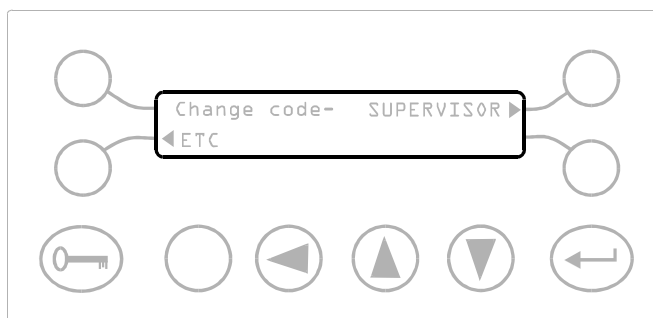
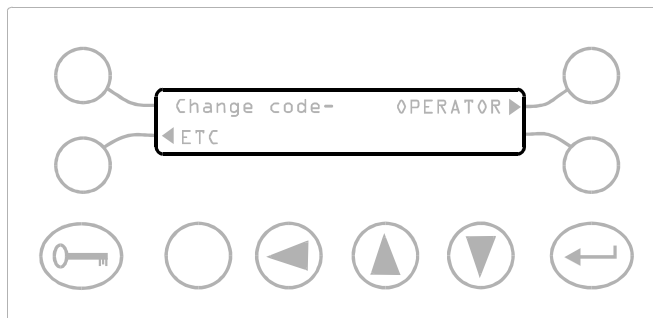
**FULL** Press the soft key next to FULL to allow any person with an OPERATOR security code to adjust phase and sensitivity.



# OPERATING INSTRUCTIONS

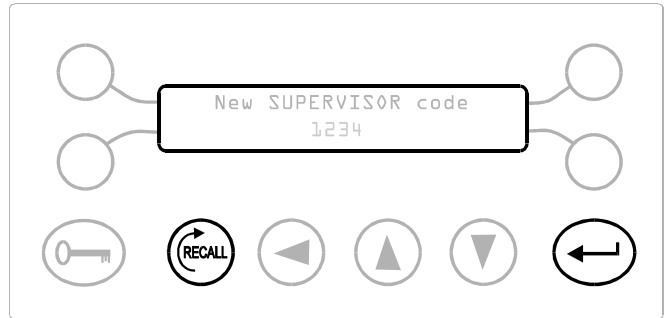
## Changing Security Codes

- 1) Press the ETC key to step through the following four displays,
- 2) Press the soft key adjacent to the required security code (i.e. OPERATOR, SUPERVISOR, ENGINEER, QA INSPECTOR or VIEWING)
- 3) If the soft key adjacent to SUPERVISOR is pressed the display opposite will appear.
- 4) The cursor appears under the first digit. Use the up and down keys to change the number and then press the ENTER key. A \* replaces the number and the cursor moves to the next digit.
- 5) Repeat Step 4) for the remaining three digits.



## OPERATING INSTRUCTIONS

- 6) When the last digit has been set press the ENTER key and the display opposite appears.
- 7) Press the ENTER key if the number is correct, and return to the Engineer Mode.
- 8) If the number is not correct press the RECALL key and carry out Steps 1) to 7) again.



# OPERATING INSTRUCTIONS

## SPEED SETUP

### Introduction

This menu is used to set-up the speed range and product speed for the detector

The performance of metal detectors may be improved if a detector is able to focus in on a specific speed range, rather than have to cope with unknown speed ranges.

In the speed menu it is possible to set the detector into one of three ranges and then further define the product speed automatically in terms of metres/minute (feet/minute in U.S. versions)

### Notes

- (1) Any settings altered in this menu will affect ALL of the product numbers.
- (2) The features Product Signal Cancellation and Automatic tracking are not available in the VARIABLE speed range.



NOTE

**Remember to record all settings on the Settings Sheets at the rear of the manual.**

---

### Speed range

This display is used to select between one of three possible speed modes.

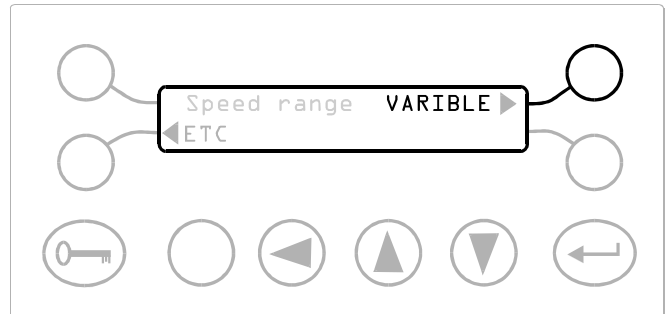
**NORMAL** This mode allows for precise calibration of the speed of the product to provide additional filtering inside the detector which in most cases will allow greater sensitivities to be used.

**FAST** This mode allows for faster speeds than the NORMAL mode to be achieved. The additional performance increase of the NORMAL mode is NOT available in this mode.

**VARIABLE** This mode allows for products with varying speeds to be used. The additional performance increase of the NORMAL mode is NOT available in this mode.

In most cases selecting NORMAL speed range will allow better sensitivities to be attained than the other two speed ranges

Press the soft key adjacent to VARIABLE/NORMAL/FAST message to successively select the different speed ranges. When the speed range required is showing on the display press ETC to move to the next display.



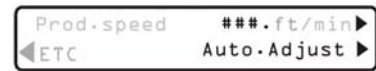
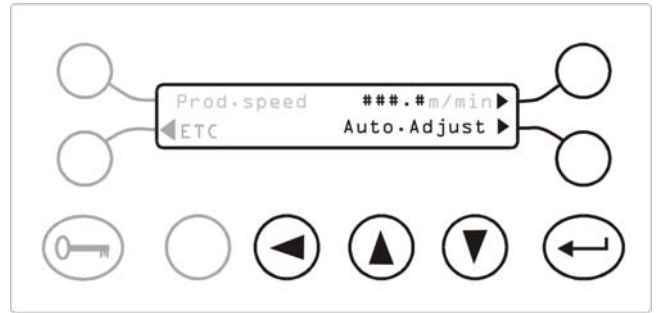
# OPERATING INSTRUCTIONS

## Product speed

This display allows the speed of the product to be set either manually or automatically.

Press the soft key adjacent to product speed to manually set the product speed. Press the ENTER key when finished.

Press the soft key adjacent to Auto.Adjust to automatically set the product speed.



*U.S. version only*

# OPERATING INSTRUCTIONS

## AUTO. TRACKING SETUP

### Introduction

This menu allows all of the parameters that affect the operation of the Automatic tracking to be set-up

The automatic tracking feature measures the signals from packs passing through the detector aperture and attempts to adjust the phase and sensitivity of the detector to give the optimum performance for the current product.

The adjusted values of sensitivity and phase may vary from the pre-set values due to temperature effects on the product or due to differences in composition of successive product batches.



NOTE

When automatic tracking is enabled the current values for sensitivity and phase (known as the 'tracked values') will be flashed up on to the 'Sens and Phase' display in the Engineer Mode every few seconds. The text 'Track...' is also shown on the display at the same time to indicate that the values are the 'tracked' values.

In the Running mode the bottom line of the first display will also flash alternatively between the 'Safeline ltd' and "Auto. Tracking..." message to indicate that tracking has been enabled.

### Notes for correct operation

The Automatic tracking feature requires that a pack sensor is fitted and selected in the pack sensor menu.

For correct operation of the Automatic Tracking feature the 'Sensor Distance' value in the pack sensor menu must be set as accurately as possible.

Automatic tracking can NOT operate when the 'Speed range' is set to VARIABLE.

The Product Signal Cancellation feature will be automatically DISABLED for a product if automatic tracking is enabled for the same product (and vice versa)



NOTE

The set-up performed here will apply equally to all product numbers that are operating in the Automatic Tracking feature.



NOTE

**Remember to record all settings on the Settings Sheets at the rear of the manual.**

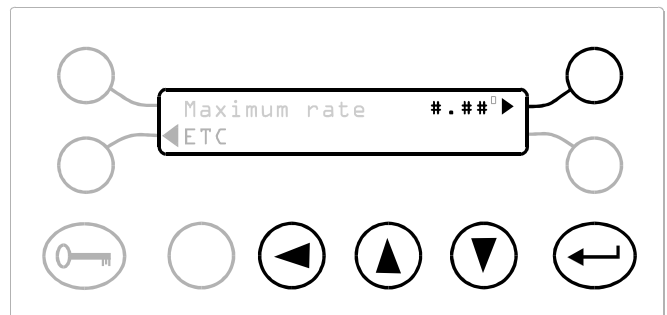
---

### Automatic tracking maximum rate

This display is used to set the maximum amount that the phase is allowed to change between two successive pack measurements.

Press the soft key adjacent to Maximum rate to change the maximum allowable rate of phase change per pack.

Press the ENTER key when the correct maximum rate is showing.



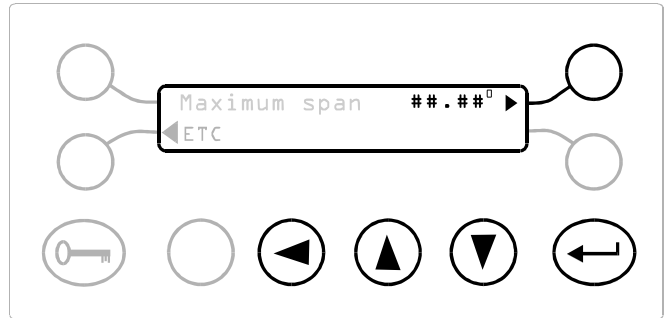


## Automatic tracking maximum span

This display is used to set the maximum amount that the phase may change from its pre-set value.

Press the soft key adjacent to Maximum span to change the maximum allowable change of phase.

Press the ENTER key when the correct maximum span is showing



## Automatic tracking damping

This number corresponds to how quickly the automatic tracking will react to changes in phase and sensitivity.

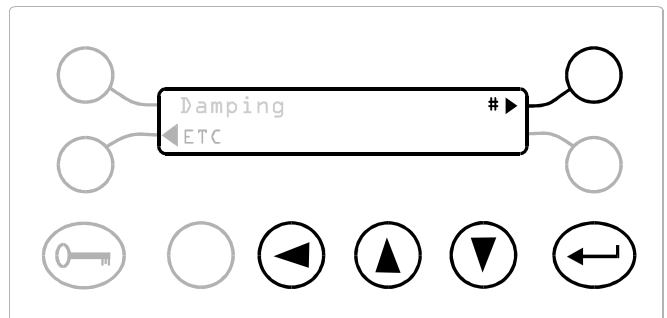
Press the soft key adjacent to Damping to change the speed of response of the automatic tracking.

Press the ENTER key when the correct damping is showing



NOTE

A low value for damping means a quick response - a high value for damping means a slow tracking response.



# OPERATING INSTRUCTIONS

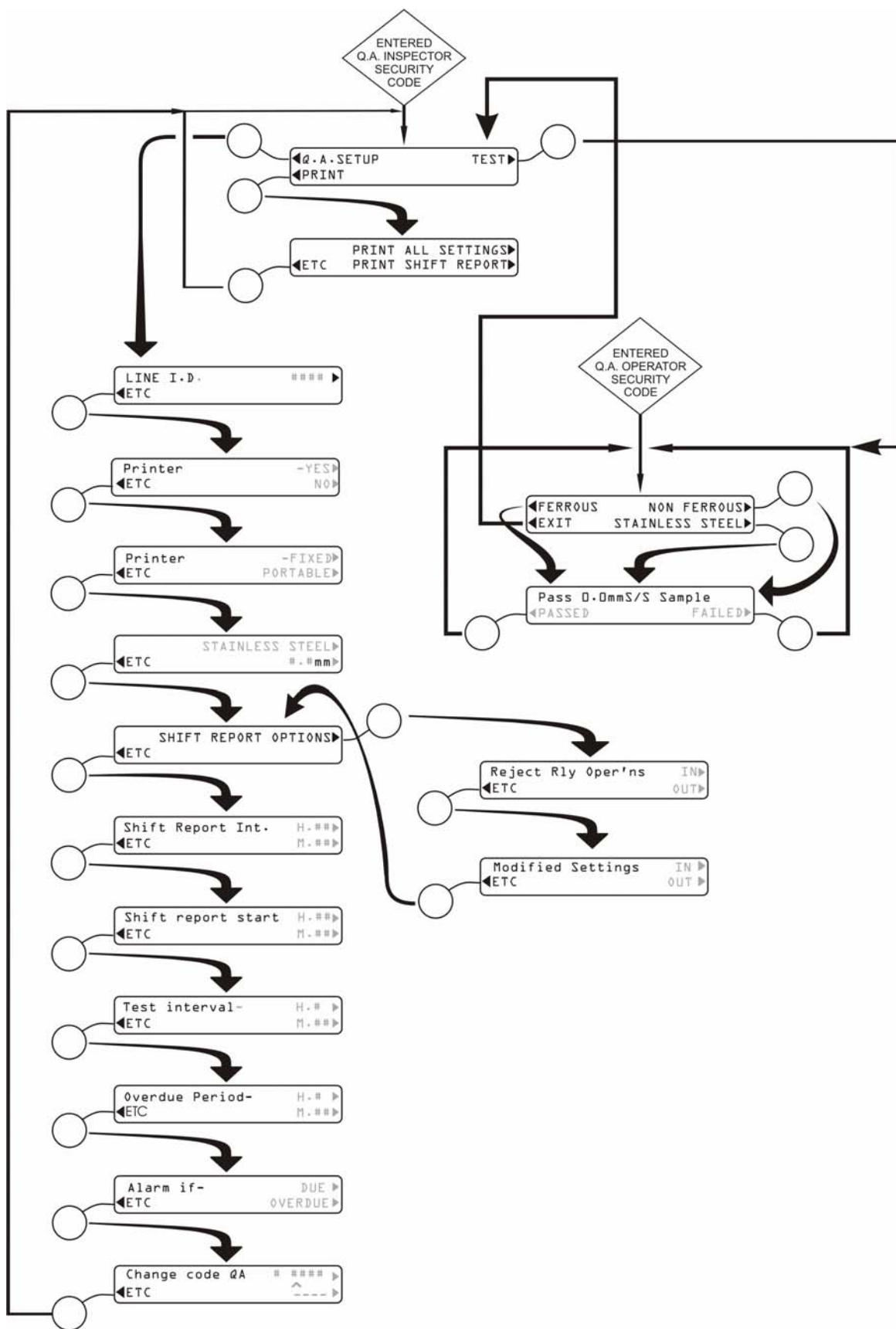


Fig 18 QA Inspector And Operator Flow Chart

## QA INSPECTOR MODE (OPTION)

(Default security code = 0004)

### Introduction

The performance validation routine (PVR) helps the users comply with ISO 9000 and BS5750 by ensuring that the detector system is tested and operating to the users specified quality assurance (QA) standards of performance.

The quality standards of many user companies require the detector and its reject system to be manually tested at specified intervals by authorised QA personnel to validate compliance.

QA personnel may programme the detector to indicate when testing is required and to give an alarm if testing is not carried out at the appropriate time. Individual QA personnel may be allocated a personnel security code which would be used to ensure that the individual responsible for testing does so at the specified time.



NOTE

**Remember to record all settings on the Settings Sheets at the rear of the manual.**

### Printer

Although effective as a feature in its own right the PVR is most effective when used in conjunction with a printer; the printer will provide a date and time stamped hard copy print out showing when the detector was tested and by whom.

The hard copy print out can be used to demonstrate authorised personnel's compliance with company standards and hence the user companies compliance with the agreed quality standard. This may prove invaluable to companies wishing to demonstrate compliance with the ISO 9000, BS5750, the UK Food Act, and for users supplying the major retail organisations with strict detector standards.

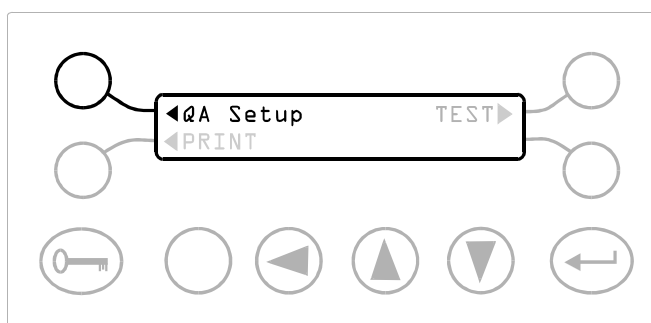
The printer also records general information relating to the detector performance, it will date and time stamp events such as rejections and changes made to the detector settings. The printer is a very useful management tool for recording events that affect detector performance.

Refer to Appendix C for illustrations of typical printouts.

# OPERATING INSTRUCTIONS

## Configuring the Performance Validation Routine

On entering the QA Inspector's mode press the soft key adjacent to QA SETUP



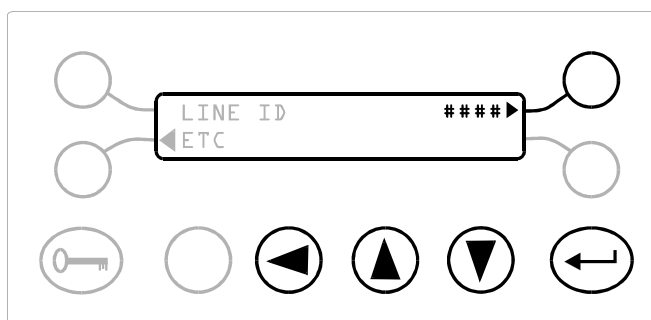
## Line Identification

This is a number that is printed near the beginning of all printouts.

**LINE ID** - Use the cursor key and up and down keys to set the line identification number.

For example the left hand two digits could be the line number and the right hand two digits could be the metal detector number.

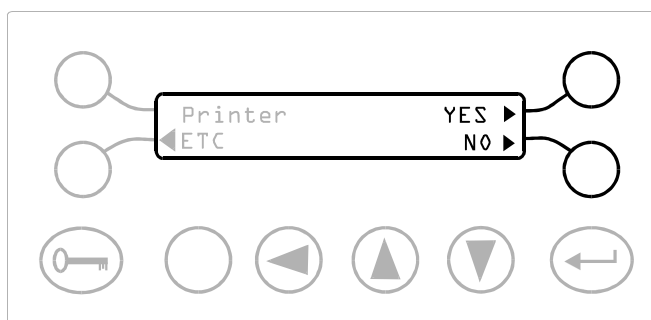
Press ENTER when the required line identification is showing.



## Printer Fitted

**YES** - Select YES if a printer is installed

**NO** - Select NO if there is no printer installed.

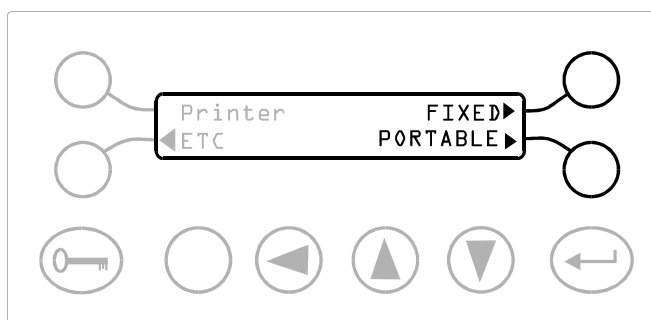


## Printer Fixed/Portable

Portable printers will not give a "data collection unit not ready" message if a QA test is performed without a printer attached. Fixed printers will always give the message if a printer is not connected.

**FIXED** - Press the soft key adjacent to FIXED if the printer is permanently connected.

**PORTABLE** - Press the soft key adjacent to PORTABLE if the printer is not permanently connected.



# OPERATING INSTRUCTIONS

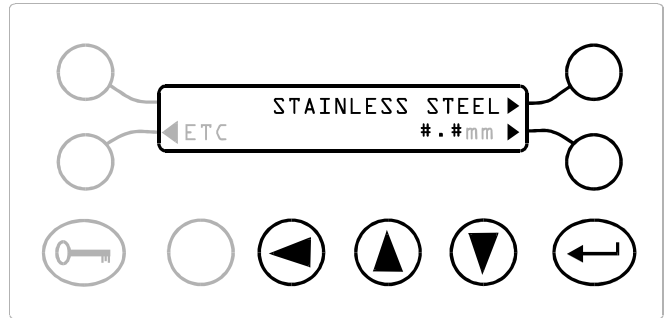
## Test Samples

Press the soft key adjacent to the material type to select either a Ferrous, Non-Ferrous or Stainless Steel sample.

Press the soft key adjacent to the mm and use the cursor key and up and down keys to set the required sample size.

Press ENTER when the correct size is showing.

Different sizes can be set for all three materials.



## Shift Report Options

Press the soft key adjacent to SHIFT REPORT OPTIONS to allow setting of the parameters that will be recorded on the timed and manual printouts.

At the Reject Relay Operations display press a soft key adjacent to IN or OUT.

**IN** - Select IN to include the date and time of all reject relay operations which have occurred, since the last shift report, in the print out of the current shift report.

**OUT** - Select OUT to prevent the print out of the data and time of all reject relay operations between shift printouts.

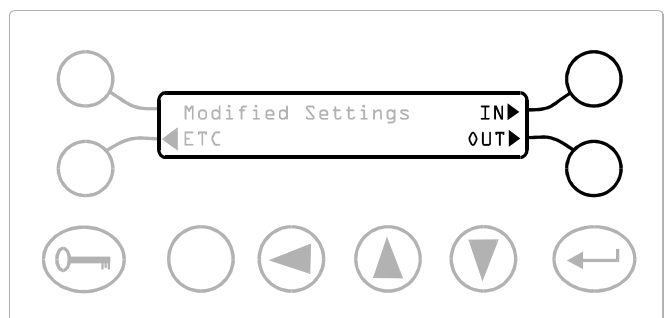
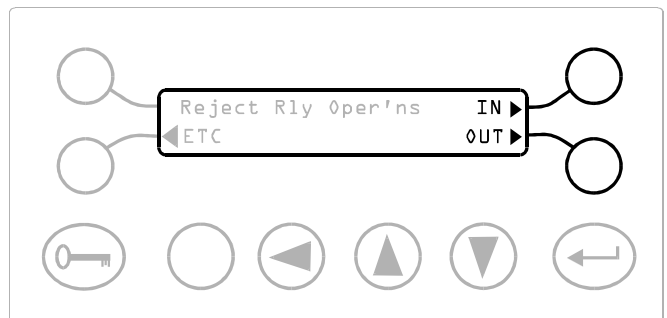
At the Modified Settings display press a soft key adjacent to IN or OUT

**IN** - Select IN to include certain settings which have been changed since the last shift report, in the current shift report. The shift report will include the settings new value and the date and time that it was changed.

The settings which are recorded are :

- Product Number
- Sensitivity
- Phase
- Timer Type
- Pack and Reject count resets
- Reject Inhibit
- Tracking
- Power drive
- Detector Speed
- Boost

**OUT** - Select OUT to prevent the recording and print out of any changes to the settings between shift printouts.



# OPERATING INSTRUCTIONS

## Shift Report Interval

The shift report can be automatically printed on a timed basis. This display allows the QA inspector to adjust the interval between printouts to a maximum interval of 24 hours 0 minutes.

**H** - Press the soft key adjacent to H to adjust the hours value. The maximum number of hours is 24. Use the up and down keys to change the value. Press the ENTER key when the correct number of hours is shown.

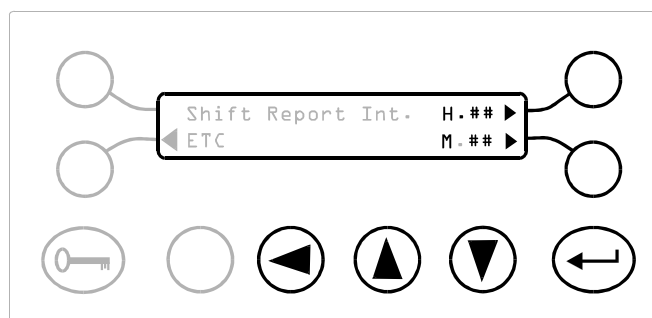
**M** - Press the soft key adjacent to M to adjust the minutes value between 0 and 59.

Use the up and down keys to change the value.

Press the ENTER key when the correct number of minutes is shown.

### NOTE :

Setting the Shift Report Interval time to 0:00 will disable the shift report facility.



## Shift Report Start Time

This display allows the QA inspector to specify a start time for the automatic printing of shift reports.

**H** - Press the soft key adjacent to H to adjust the hours value between 0 and 23.

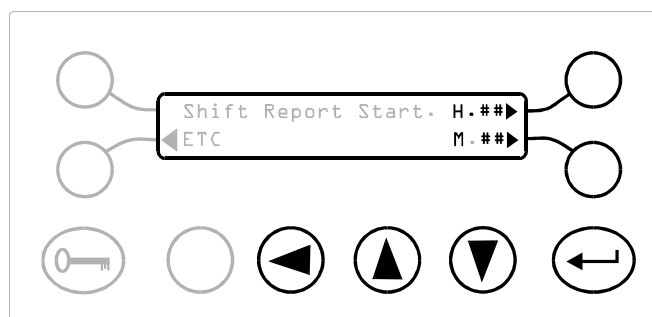
Use the up and down keys to change the value.

Press the ENTER key when the correct number of hours is shown.

**M** - Press the soft key adjacent to M to adjust the minutes value between 0 and 59.

Use the up and down keys to change the value.

Press the ENTER key when the correct number of minutes is shown.



## Test Interval

This display allows the QA inspector to set the time period between which the detector requests the QA personnel to carry out a performance check.

At the time interval specified the message, 'REQUEST FOR PERFORMANCE CHECK' appears on the display.

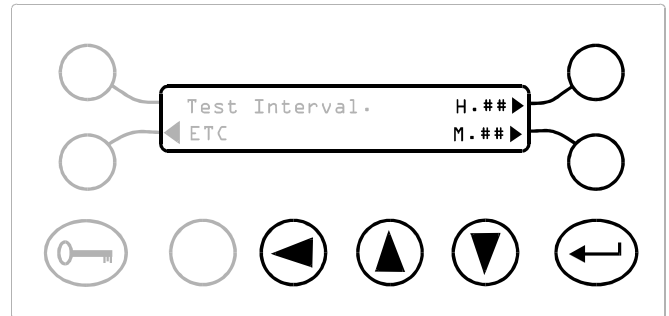
The test interval time is restarted once a performance check has been completed.

**H** - Press the soft key adjacent to H to adjust the hours value. The maximum number of hours is 8. Use the up and down keys to change the value. Press the ENTER key when the correct number of hours is shown.

**M** - Press the soft key adjacent to M to adjust the minutes value between 0 and 59. Use the up and down keys to change the value. Press the ENTER key when the correct number of minutes is shown.

### NOTE :

Setting the time to 0:00 will disable requests for timed performance checks.



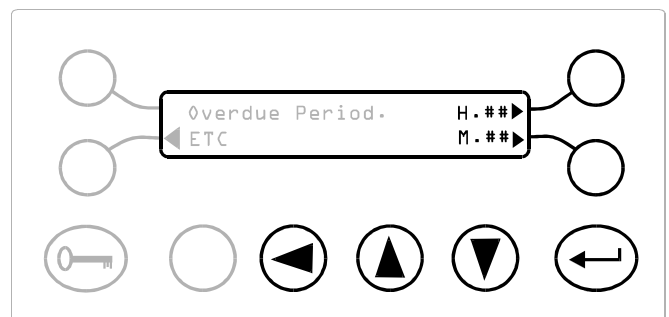
## Overdue Period

This display allows the QA inspector to adjust the time period allowed, following a performance check request, before the test becomes overdue.

Once the test becomes overdue the 'REQUEST FOR PERFORMANCE CHECK' message is replaced with 'OVERDUE FOR PERFORMANCE CHECK'. At the same time the bar graph display and buzzer are sequenced on and off to attract the operator's attention.

**H** - Press the soft key adjacent to H to adjust the hours value. The maximum number of hours is restricted to half of the test interval time. Use the up and down keys to change the value. Press the ENTER key when the correct number of hours is shown.

**M** - Press the soft key adjacent to M to adjust the minutes value between 0 and 59. Use the up and down keys to change the value. Press the ENTER key when the correct number of minutes is shown.



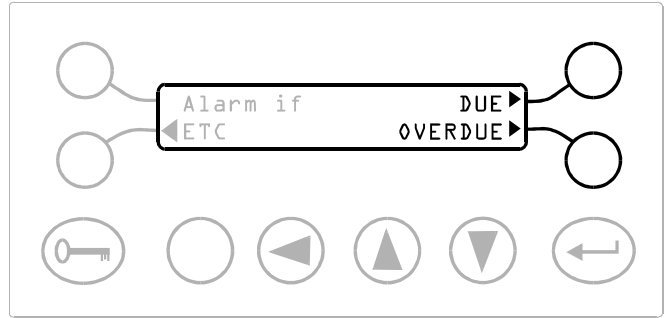
# OPERATING INSTRUCTIONS

## Alarm If Overdue

An alarm output is available if a Performance Check becomes either due or overdue.

**DUE** - Press the soft key adjacent to DUE if an alarm is required when a Performance Check is due.

**OVERDUE** - Press the soft key adjacent to OVERDUE if an alarm is required when a Performance Check is overdue.



## Change QA Operator Code

This display allows the setting of up to nine QA operator security codes.

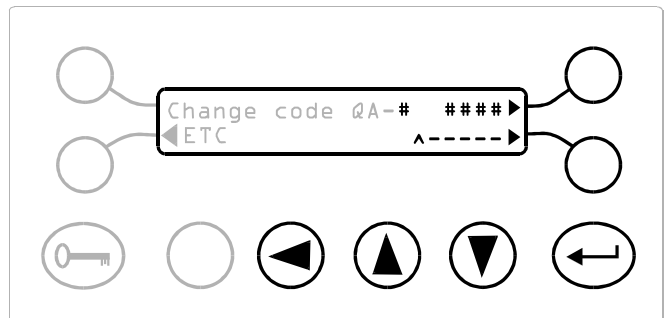
Press the soft key adjacent to the dotted line to select a QA operator number (1 to 9).

Press the soft key adjacent to ##### and change the code number using the cursor key and up and down keys.

Press the ENTER key to store the new code in memory.

Repeat the operation for as many QA Operator's as required.

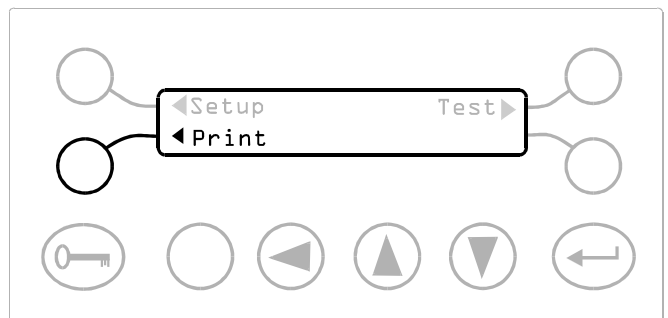
Press the ETC key to return to the first display of the QA Inspector Mode.



## QA Inspector Print Menu

From the QA Inspector Mode press the soft key adjacent to PRINT to access the print-on-demand facilities.

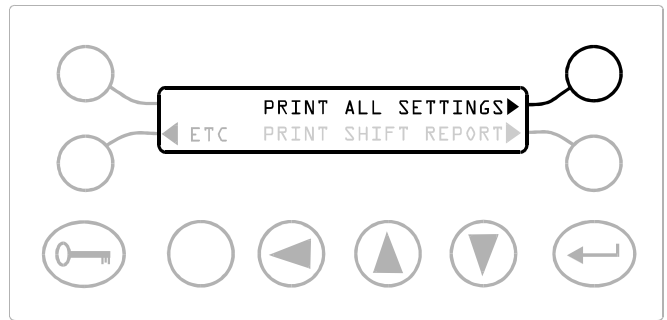
For sample printouts see Appendix C.





# OPERATING INSTRUCTIONS

**PRINT ALL SETTINGS** - Press the soft key adjacent to PRINT ALL SETTINGS to obtain a printout of the current values of all the Engineer Mode and QA Inspector Mode settings.



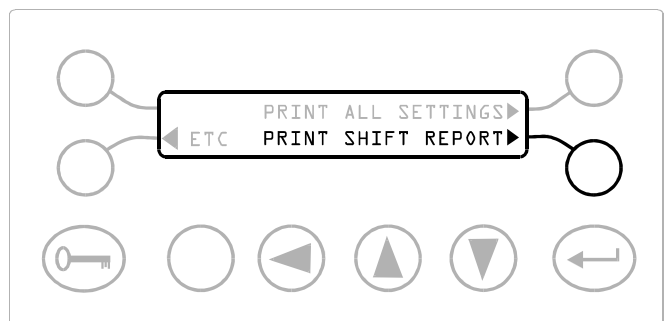
**PRINT SHIFT REPORT** - Press the soft key adjacent to PRINT SHIFT REPORT to obtain a printout of the stored entries from the start of the current shift.

## Notes.

- 1) The content of the shift-report printout will depend on which of the following two options were selected by the QA Inspector.

*(See the Shift Report Options section earlier).*

- a) Any reject relay operations during the shift,  
and
  - b) Any settings that have been modified during the shift
- 2) After printing the shift-report the detector will clear all the current shift information and start collecting information for the next shift.

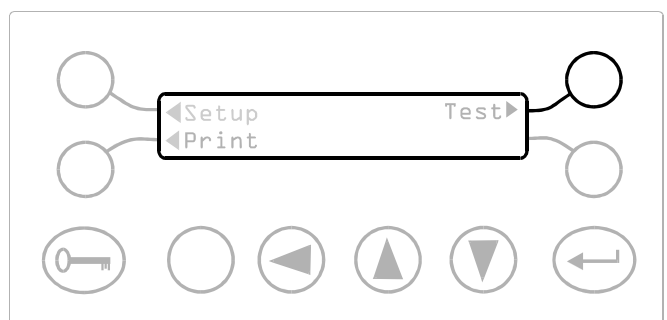


## QA Inspector Test Menu

From the QA Inspector Mode press the soft key adjacent to TEST to access the QA Operator Mode, (performance checking).

(See the QA Operator Mode section for details of this operating mode).

Note. The performance check printout occurs as soon as a performance check is completed by either the QA Inspector or one of the QA Operators.



# OPERATING INSTRUCTIONS

## QA OPERATOR MODE

### Introduction

This mode is for carrying out a performance check of the detector, and thus provide immediate validation of the detector's integrity.

The QA Inspector has the facility to set a timer in the detector that will cause a 'REQUEST FOR PERFORMANCE CHECK' message to appear at pre-set intervals.

A QA Operator or the QA Inspector may perform these tests to validate the detector at any time however note that the test interval timer will be restarted from 00:00 minutes as soon as a test has been performed.

The time that the next test will be requested is displayed in the Running Mode. Please see the Time section of the Running Mode for details.

A printout is automatically printed immediately a performance check is carried out, providing the printer option has been selected by the QA Inspector.

A sample of the performance check printouts is provided in appendix C.

---

### QA Operator Security Codes

All detectors are shipped from the factory with the following security codes for QA Operators modes;

Code 1000 = QA Operator 1 Mode

Code 2000 = QA Operator 2 Mode

|  
etc

|  
Code 9000 = QA Operator 9 Mode

---

### Carrying Out a Performance Check

#### Notes on the Test Sample

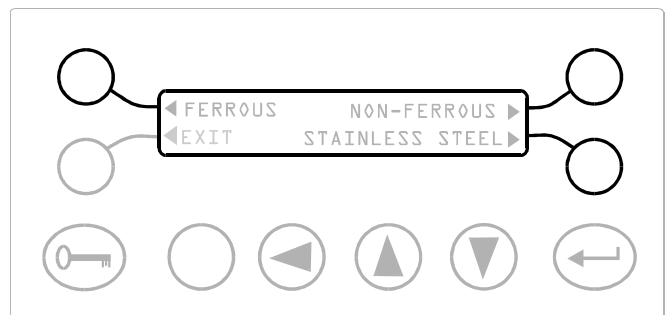
Always pass the test sample through the detector aperture with the product.

If the detector is inspecting individual products prepare a sample pack(s) with the sample(s) to be tested placed at the centre rear of the pack(s).

---

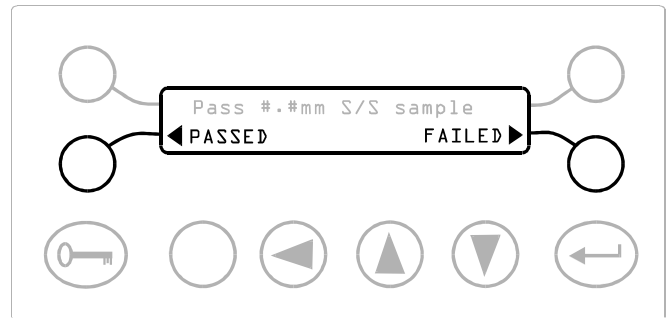
#### Select Test Material

- 1) Press a soft key that is adjacent to the material of your test sample.



## Select Test Result

- 1) The display shown opposite appears.



- 2)
  - a) If inspecting individual products place the pack on the conveyor and allow it to pass through the detector aperture without skewing or slipping.
  - b) If inspecting continuous or loose product place the test sample on the conveyor belt, (or into the product flow), and allow it to pass through the detector aperture.
- 3) Check that the test sample has been detected by monitoring the detect led on the detector front panel.
- 4) Where applicable check that the reject device operates to reject the test sample.
- 5) Press the soft key that is adjacent to the test result, e.g. PASSED or FAILED.
- 6) The display shown previously will re-appear.
- 7) If there are more test samples to be checked then repeat steps 1 to 4 for each sample.

---

## Worst case testing

Follow the guidelines below to ensure that the detector is tested to its worst case limits.

- 1) Check the pack(s) with the test sample(s) placed at the front and middle of the pack(s).
- 2) Check the pack(s) with larger test sample(s).
- 3) For loose product applications check the operation using two sample placed at different distances apart on the conveyor.

# OPERATING INSTRUCTIONS

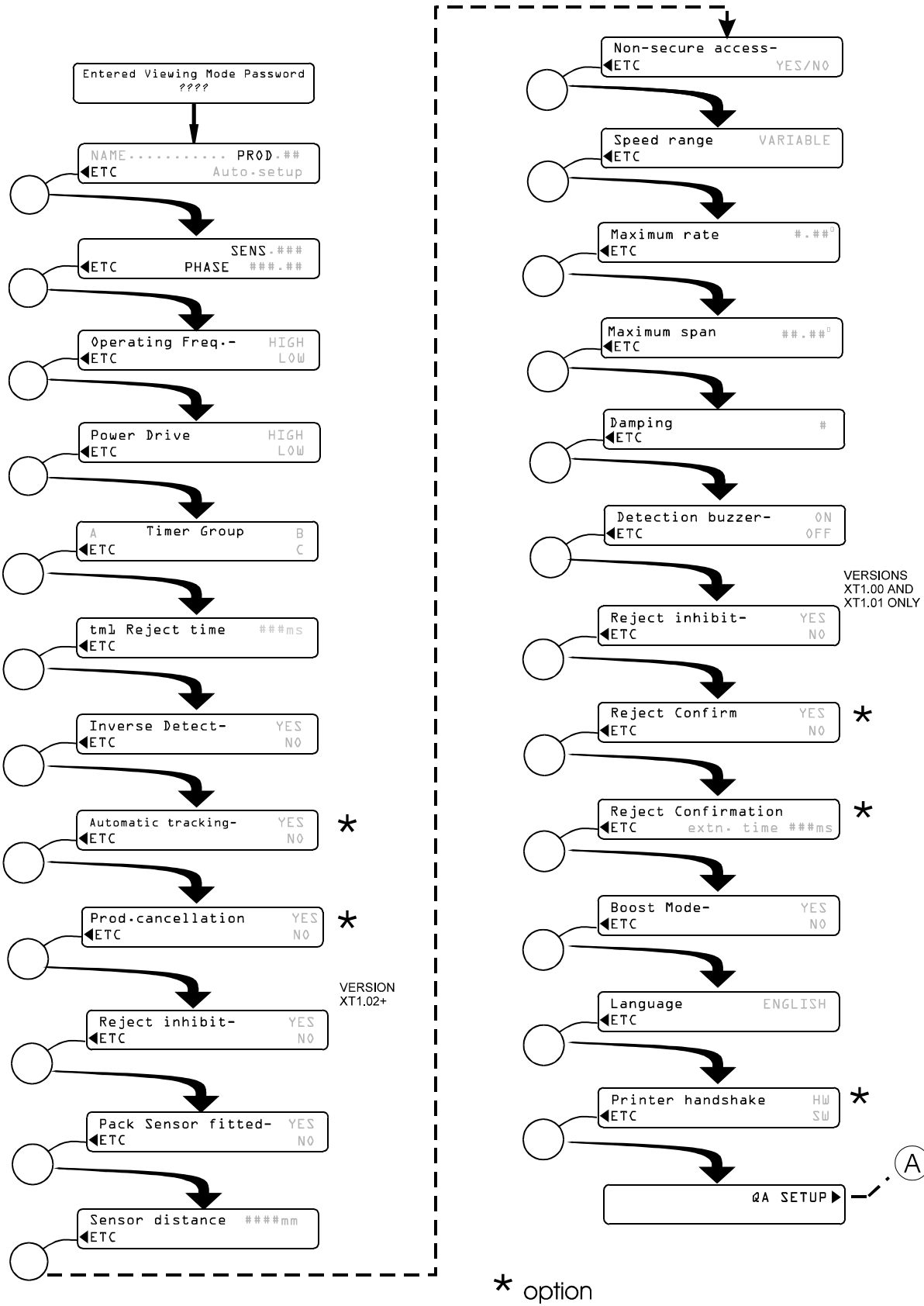


Fig 19 Viewing Mode Flow Chart

## VIEWING MODE

(Default security code = 0005)

### Introduction

Viewing Mode enables the user to see all the settings available in the Engineer Mode and the QA Inspector Mode, but does not allow any alteration of these settings.

None of the security codes that may be set in the above two modes are visible inside the Viewing Mode.

A security code for the Viewing Mode can be setup from the Engineer Mode.

The sequence of displays is shown on the flow chart Figure 19.

Each display can be viewed in turn by pressing the soft key adjacent to ETC.

### Note:

In the Viewing Mode it is only possible to see product related settings, such as phase and sensitivities, for the currently selected product number. Similarly, frequency dependent settings will only be seen for the current frequency of operation.

The product number cannot be changed from the Viewing Mode.



NOTE

**Remember to record all settings on the Settings Sheets at the rear of the manual.**

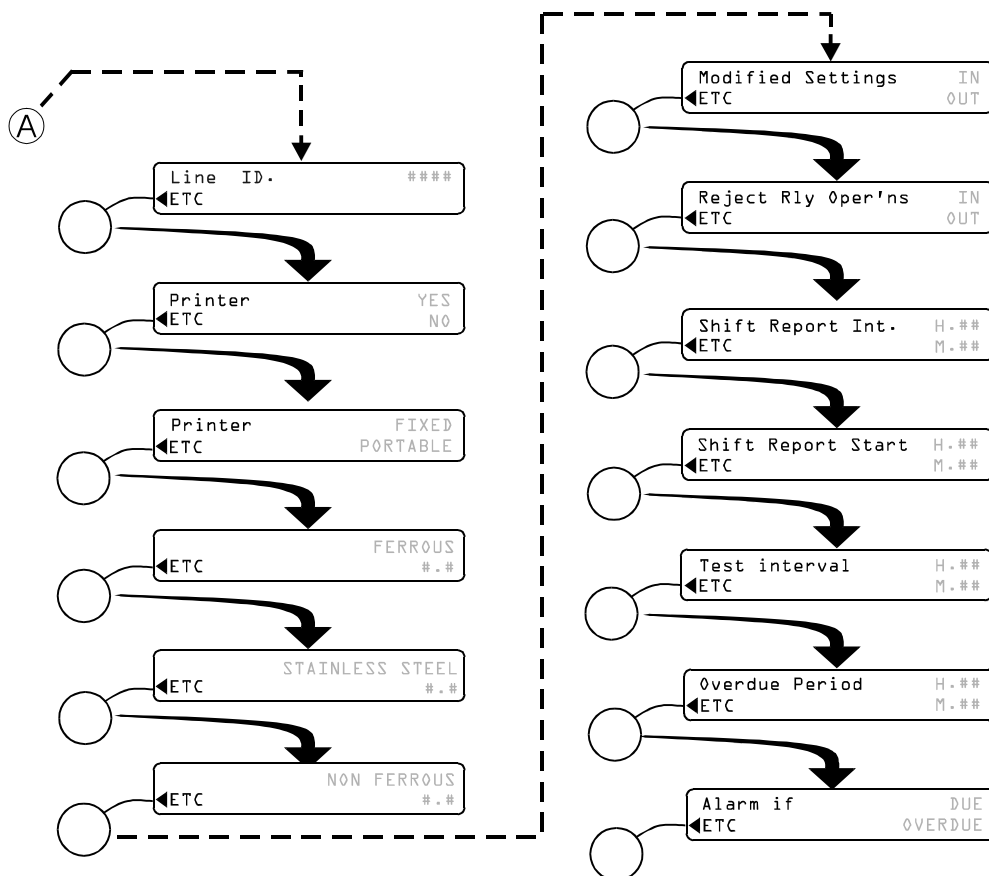


Fig 20 Viewing Mode Flow Chart cont..

# OPERATING INSTRUCTIONS

## REJECT TIMERS INTRODUCTION



NOTE

**Remember to record all settings on the Settings Sheets at the rear of the manual**

### Recommended Applications

Listed below are various types of reject mechanisms along with the recommended timer type for the mechanism. For variable speed applications substitute timer type tm3 for tm2 or tm3G for tm2G.

| REJECT MECHANISM                        | TIMER TYPE |     |           |
|---|------------|-----|-----------|
|   | tm1        | tm2 | tm2(G)    |
| Timed Audible Alarm                     | OK         | N/A | N/A       |
| Conveyor Stop                           | OK         | N/A | N/A       |
| Gravity Fall Systems                    | OK         | N/A | N/A       |
| Instant Reject with Timed Reject Period | OK         | N/A | N/A       |
| Retracting Band                         | N/A        | OK  | N/A       |
| Air Blast                               | N/A        | OK  | Preferred |
| Punch/Pusher                            | N/A        | N/A | OK        |
| Drop/lift Flap                          | N/A        | OK  | Preferred |
| Plough action diverter                  | N/A        | OK  | OK        |
| Flip action diverter                    | N/A        | N/A | OK        |

Note. N/A = Not applicable for this reject mechanism

### Timer Groups A, B or C

The engineer may allocate different timer types and settings to group A, B or C, only three selections are allowed. In general only one timer type and setting will be required for all applications.

For applications with a greater than  $\pm 25\%$  variation in pack length or for those operating at different speeds it may be necessary to have different timer settings for the different timer groups. The different timer settings may then be selected as required.

Both timer group selection and timer type setting may be made in the Engineer Mode but only timer group selection for a product number can be made from the Supervisor Mode.

### Important notes for timer setup

#### Sample size selection

Small size metal contaminants should be used during the setting of the timers; the use of large contaminants will produce errors in the settings. Use the smallest metal sample that can be detected, this should give approximately 2 to 3 red LED's on the bargraph.

If this is not possible use the smallest sample available and adjust the sensitivity setting so that the metal contaminant gives a bargraph indication of approximately 2 to 3 red LED's.

#### Product presentation

Sample products or product packs used to set up the timer should be passed through the detector aperture at their normal speed and without skewing or slipping.

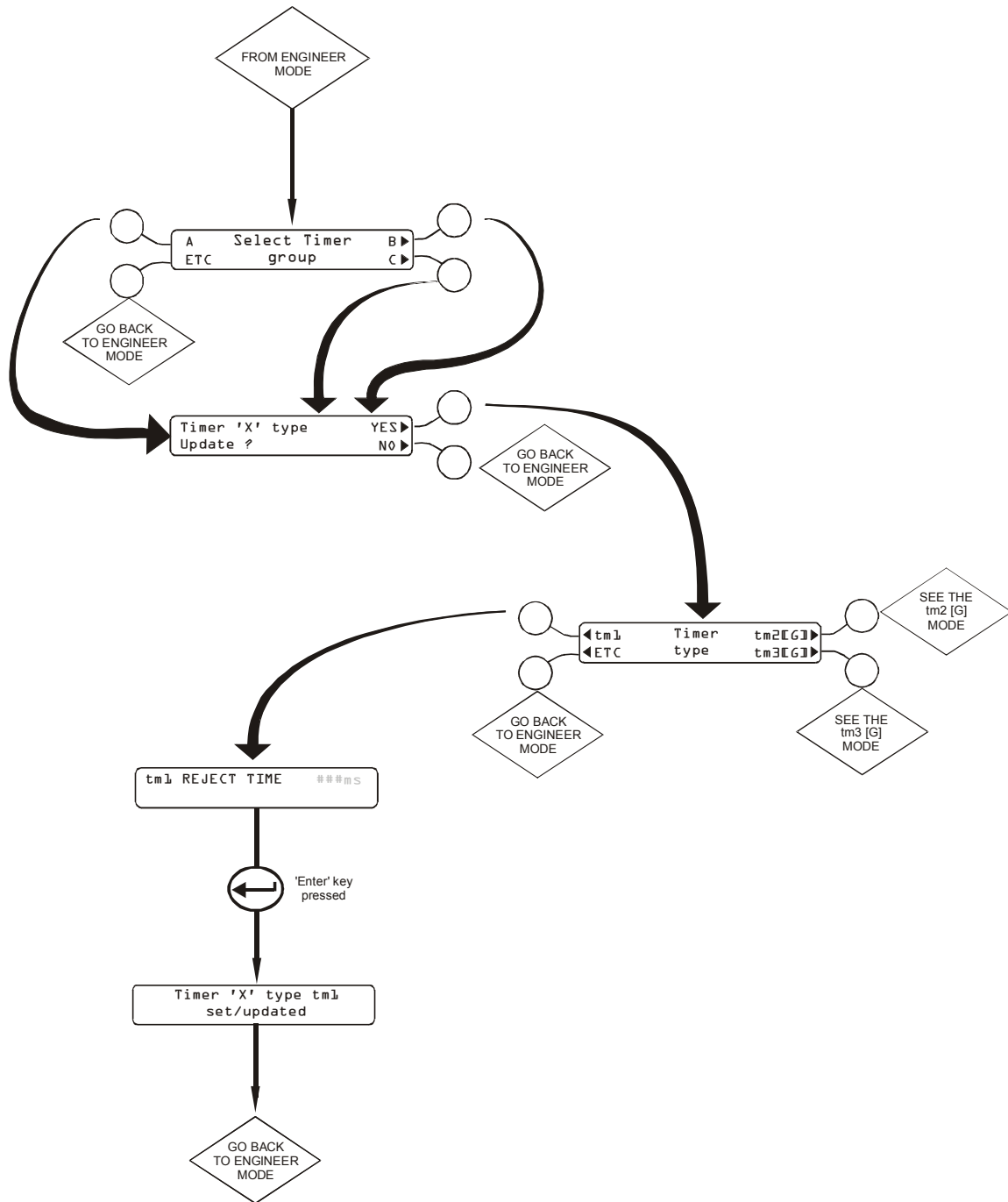
#### Pack length limitation for packaged products

Where a variety of individual products with differing lengths are being monitored ensure that for a particular timer group the variation in pack length does not exceed  $\pm 25\%$  of the pack length used to set the timer.

If the variation in pack length is greater than  $\pm 25\%$  of the length used to set the timer then a different timer group should be used for those packs that fall outside the limit.

## **Positioning of pack sensor on gated timers**

- ◇ Position the pack sensor such that the beam from the pack sensor is at a 90° to the flow of the product along the conveyor.
- ◇ The pack sensor may be positioned either side of the detector, however the packs must break the pack sensor's beam before they reach the reject device
- ◇ Ensure the pack sensor, (and reflector if fitted), are not affecting the metal detector, by infringing upon the metal detectors metal free zone.
- ◇ At conveyor speeds of 61 m/min (200 ft/min) or greater, the pack sensor must not be positioned less than 0.5 m (1.5 feet) from the reject device.
- ◇ The height and alignment of the pack sensor beam must be set so that all packs break the beam at the same leading edge position irrespective of the type or of the size of the pack.



**Fig 21 Tm1 Timer Flow Chart**



## tm1 TIMER



**Ensure you have read the REJECT TIMERS INTRODUCTION section on page 78**



**Remember to record all settings on the Settings Sheets at the rear of the manual.**

### Introduction

The tm1 timer is used in applications requiring instant rejection of contaminated products.

This timer type can be used with either packaged or loose product.

### tm1 settings

- a) Reject Time  
This is the time required by the reject device to reject the contaminated product.

### Setting Timer type tm1

The display opposite may be used to either:

- a) Select which timer group the current product number should use,
- or,
- b) Select which timer group the current product number should use AND adjust the timer group settings such as timer type, reject time, etc.



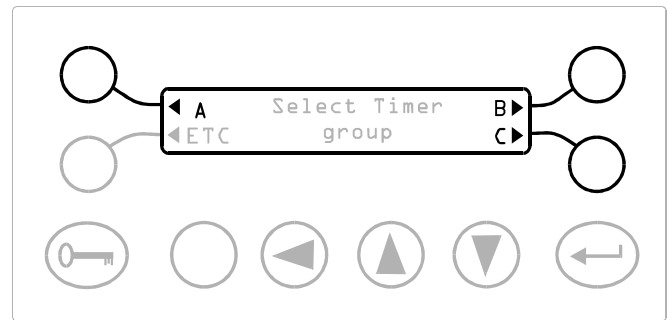
If you have already selected the timer group and pressed YES to updating the group, as per the Engineer Mode section earlier, then proceed to step 3).

- 1) Press the soft key adjacent to the required group letter, A, B or C.
- 
- 2) If you only need to select the timer group for the current product number and not adjust any of the timer group properties then
    - a) Select the soft key adjacent to NO, and go back to the Engineer Mode section.



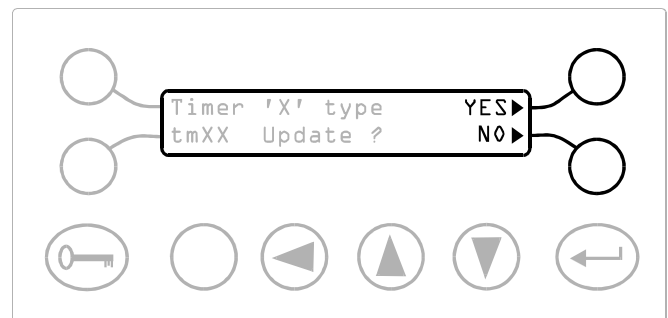
*Although NO was selected the group will be changed to the group letter selected in 1). else*

- b) Select the soft key adjacent to YES, and proceed to step 3)



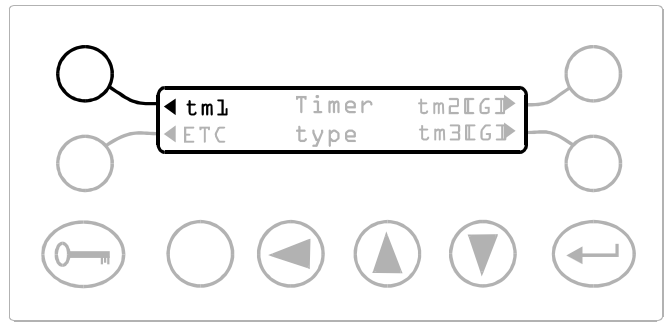
The currently selected timer group will be indicated by a flashing cursor appearing over the group letter.

In the following displays 'X' represents the timer group A, B or C as selected at step 1); tmxx represents the timer type that is currently selected for this timer group.



## OPERATING INSTRUCTIONS

- 3) Press the soft key adjacent to tm1

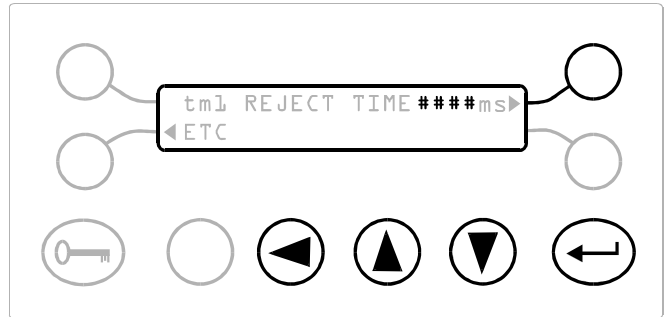


- 4) Press the soft key adjacent to REJECT TIME

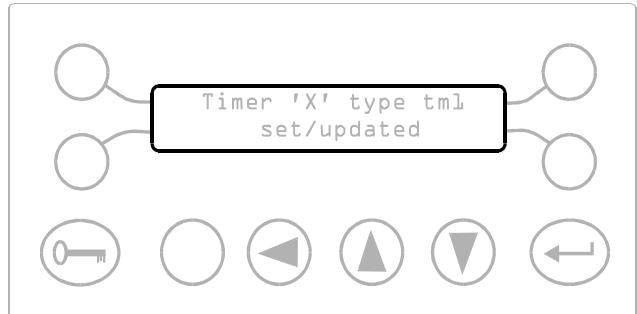
- 5) Use the cursor Up and Down keys to adjust the Reject Time to the required value.

- 6) Press the Enter key to accept the new settings.

- 7) Press the Enter key a second time to proceed to the next display.

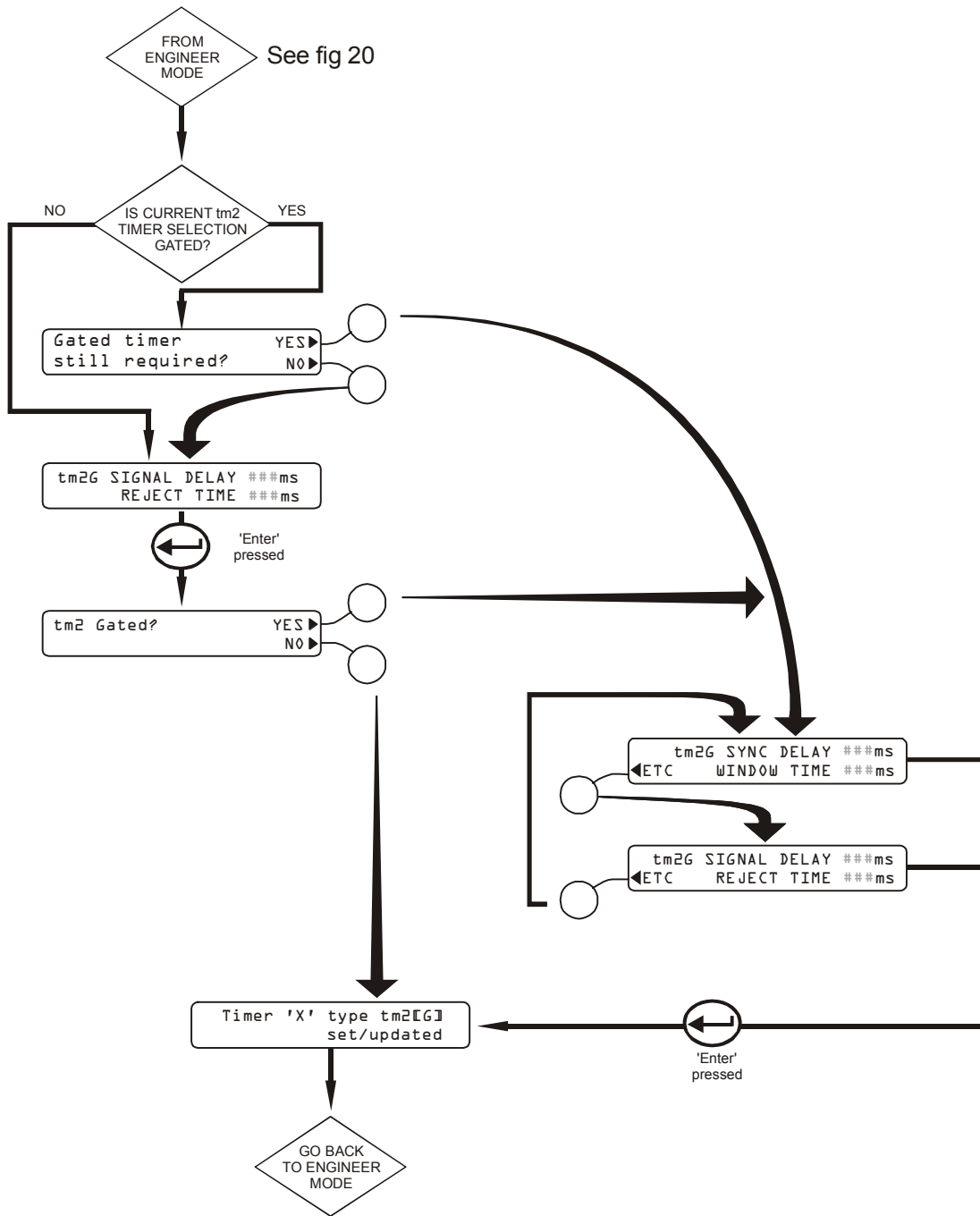


- 8) The display shown opposite will appear for five seconds before returning to the Engineer Mode display



### Testing the Reject Device.

- 9) Check the reject device operates correctly with different sizes of metal contaminant.
- 10) If for any reason the setting of the tm1 timer is not correct return to step 1) and repeat all the steps.



**Fig 22 Tm2 Timer Flow Chart**

## tm2[G] TIMER - NON GATED MODE



### CAUTION

Ensure you have read the **REJECT TIMERS INTRODUCTION** section on page 78



### NOTE

Remember to record all settings on the **Settings Sheets** at the rear of the manual.

### Introduction

The tm2 timer when used in the non-gated mode is ideal for use with loose products where the reject device is situated some distance from the metal detector.

This timer type is suitable for reject devices which include plough-action diverters, retracting bands etc.

This timer is also suitable for use with packaged products but is not as accurate as the gated version, tm2G.

### tm2 settings

#### 1) Signal Delay

This is the time taken for a metal contaminant to travel from the metal detector to the reject device.

#### 2) Reject Time

This is the time required by the reject device to reject the contaminated product.

---

### Setting up timer type tm2

The display opposite may be used to either:

a) Select which timer group the current product number should use,

or,

b) Select which timer group the current product number should use AND adjust the timer group settings such as timer type, reject time, signal delay etc.

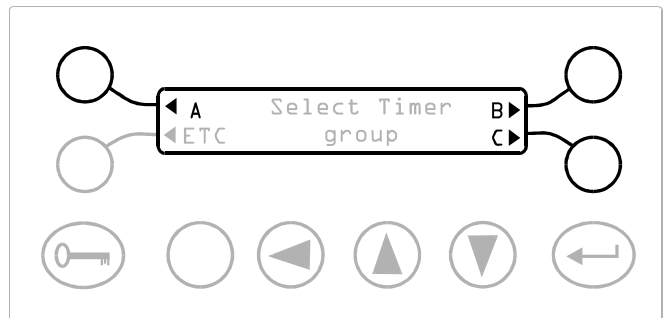


### NOTE

### REMINDER

If you have already selected the timer group and pressed YES to updating the group, as per the Engineer Mode section earlier, then proceed to step 3).

1) Press the soft key adjacent to the required group letter, A, B or C.



The currently selected timer group will be indicated by a flashing cursor appearing over the group letter.

# OPERATING INSTRUCTIONS

2) If you only need to select the timer group for the current product number and not adjust any of the timer group properties then

a) Select the soft key adjacent to NO, and go back to the Engineer Mode section.

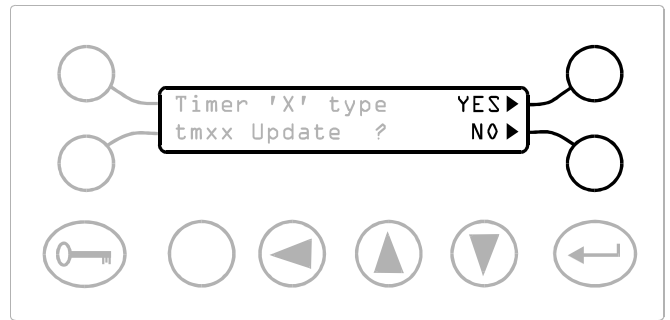


## CAUTION

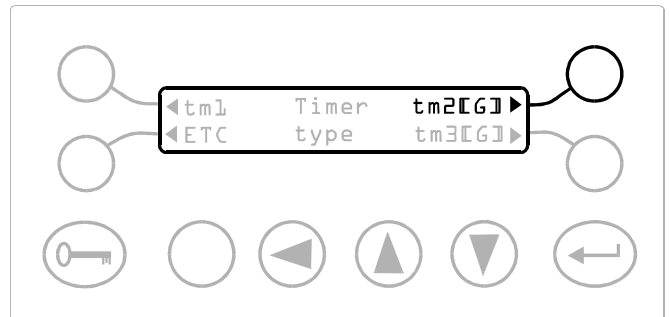
*Although NO was selected the group will be changed to the group letter selected in 1).*

else

b) Select the soft key adjacent to YES, and proceed to step 3)



3) Press the soft key adjacent to tm2[G]



4) a) If the display opposite appears, press the soft key adjacent to NO.

else

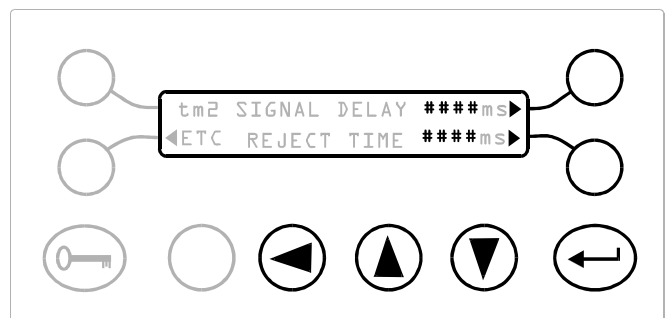
b) Proceed to step 5)



5) Press the soft key adjacent to SIGNAL DELAY

a) For packaged or separate products

- i) Place the metal contaminant at the rear /trailing edge of the product.
- ii) Pass the product with the metal contaminant attached through the detector aperture, ensuring that the product does not slip or skew.
- iii) Use the cursor Up and Down keys to adjust the Signal Delay so that the reject device operates as the front edge of the pack reaches it.



In the following displays 'X' represents the timer group A, B or C as selected at step 1); tmxx represents the timer type that is currently selected for this timer group.

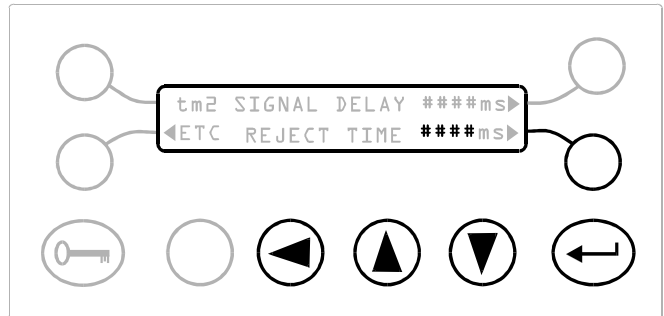
# OPERATING INSTRUCTIONS

- b) For loose products
- i) Place the metal contaminant on the centre of the conveyor belt.
- ii) Pass the product with the metal contaminant through the detector aperture.

- iii) Use the cursor Up and Down keys to adjust the Signal Delay so that the reject device operates just as the metal contaminant reaches it.

6 Press the soft key adjacent to REJECT TIME.

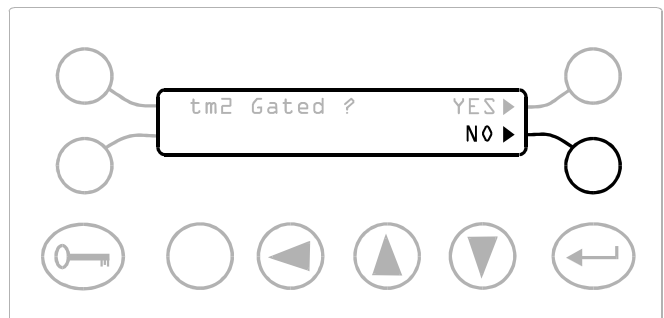
- a) For packaged or separate products
- i) Place the metal contaminant at the front or leading edge of the product package.
- ii) Pass the product with the metal contaminant attached through the detector aperture, ensuring that the product does not slip or skew.
- iii) Use the cursor Up and Down keys to adjust the Reject Time so that the metal contaminant is rejected consistently and accurately.



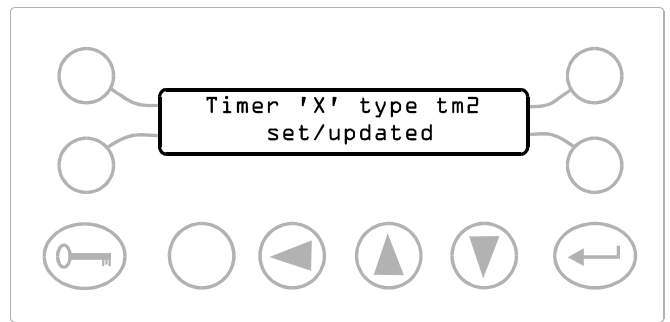
- b) For loose products
- i) Place the metal contaminant on the centre of the conveyor belt.
- ii) Pass the product with the metal contaminant through the detector aperture.
- iii) Use the cursor Up and Down keys to adjust the Reject Time so that the metal contaminant is rejected with the minimum of wasted product.

- 7) Press the Enter key to accept the new settings.
- 8) Press the Enter key a second time to proceed to the next display.

- 9) Press the soft key adjacent to NO.



- 10) The display shown opposite will appear for five seconds before returning to the Engineer Mode display.



## Testing the Reject Device.

- 11)
- a) For packaged or separate products
    - i) Check the setting of tm2 by passing the product and metal contaminant through the aperture of the detector.
    - ii) Check the reject device operates correctly with the metal contaminant at both the front and rear of the pack.
    - iii) Check the reject device operates correctly with different sizes of metal contaminant.
  - b) For loose products
    - i) Check the setting of tm2 by passing the product and metal contaminant through the aperture of the detector.
    - ii) Check the reject device operates correctly with the metal contaminant at different positions on the conveyor belt.
    - iii) Check the reject device operates correctly with different sizes of metal contaminant.
    - iv) Also check the reject device operates correctly with two metal contaminants spaced at different distances apart on the conveyor belt.
- 12) If for any reason the setting of the tm2 timer is not correct return to step 1) and repeat all the steps.

## tm2G TIMER - GATED MODE



### CAUTION

Ensure you have read the **REJECT TIMERS INTRODUCTION** section on page 78



### NOTE

Remember to record all settings on the **Settings Sheets** at the rear of the manual.

### Introduction

The tm2G gated timer is used to give precise rejection of packaged or individual products.

The use of gating via a pack sensor ensures that the rejection is independent of the position or size of the metal contaminant within the product.

This timer type is suitable for reject devices which include air-blast diverters, drop/lift flap diverters, punch or pusher units etc.

### tm2G settings

- 1) Signal Delay  
2) This is the time taken for a metal contaminant to travel from the metal detector to the reject device.
- 2) Reject Time  
to This is the time required by the reject device to reject the contaminated product.
- 3) Window time

This time is equal to twice the time a single pack takes to pass by the pack sensor

This time is measured and calculated automatically by the detector during the timer setup.

- 4) Sync delay

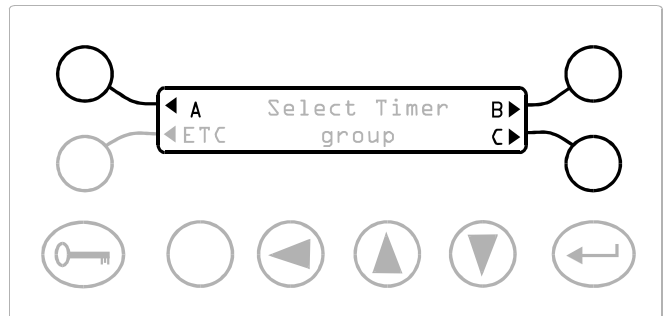
This is the time taken for the pack to travel from the pack sensor to the reject device.

---

### Setting up timer type tm2G

The display opposite may be used to either:

- 1) Select which timer group the current product number should use,
- or,
- 2) Select which timer group the current product number should use AND adjust the timer group settings such as timer type, reject time, signal delay etc.



The currently selected timer group will be indicated by a flashing cursor appearing over the group letter.



### NOTE

### REMINDER

If you have already selected the timer group and pressed YES to updating the group, as per the Engineer Mode section earlier, then proceed to step 3).

- 1) Press the soft key adjacent to the required group letter, A, B or C.



# OPERATING INSTRUCTIONS

2) If you only need to select the timer group for the current product number and not adjust any of the timer group properties then

a) Select the soft key adjacent to NO, and go back to the Engineer Mode section.



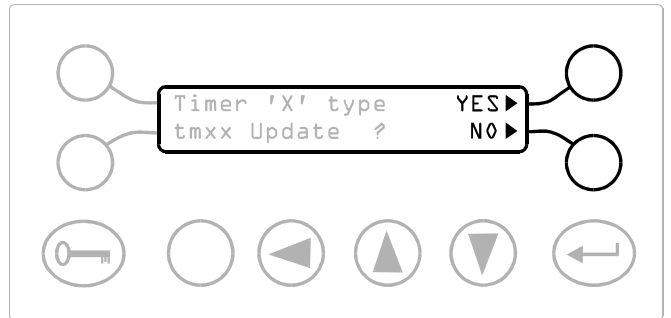
## CAUTION

*Although NO was selected the group will be changed to the group letter selected in 1).*

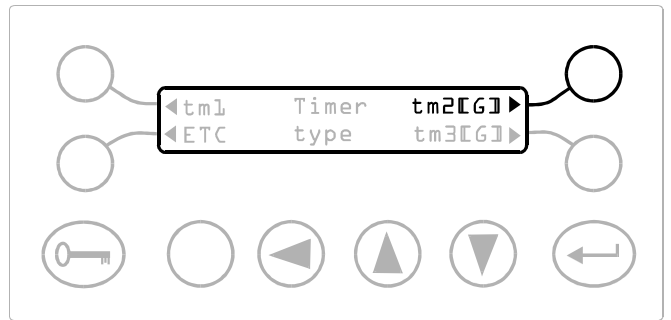
else

b) Select the soft key adjacent to YES, and proceed to step 3)

In the following displays 'X' represents the timer group A, B or C as selected at step 1); tmxx represents the timer type that is currently selected for this timer group.



3) Press the soft key adjacent to tm2[G]



4)

a) If the display opposite appears

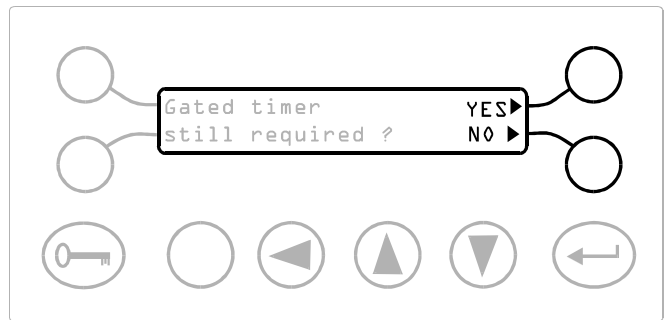
i) Press the soft key adjacent to NO if you are setting up the timer for the first time,

else

ii) If you are fine tuning an existing tm2G setting, press the soft key adjacent to YES, then go to step 10).

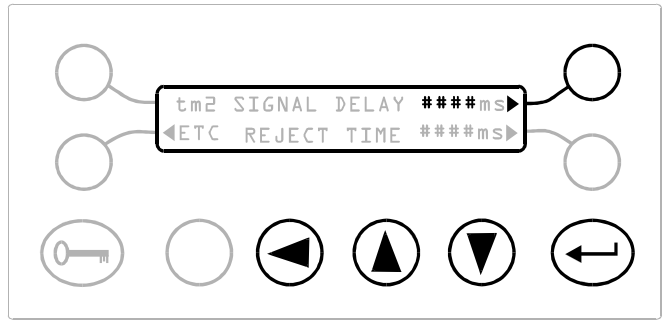
else

b) Proceed to step 5).

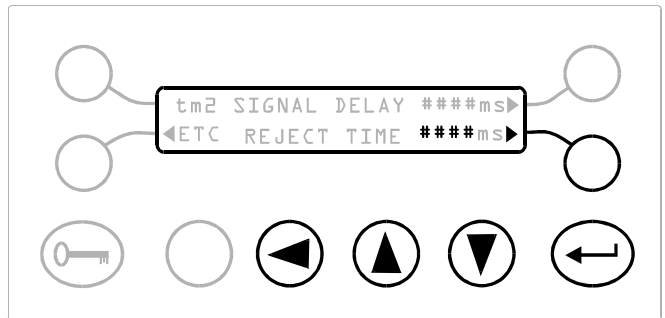


## OPERATING INSTRUCTIONS

- 5) Press the soft key adjacent to SIGNAL DELAY
- Place the metal contaminant at the rear or trailing edge of the product package.
  - Pass the product with the metal contaminant attached through the detector aperture, ensuring that the product does not slip or skew.
  - Use the cursor Up and Down keys to adjust the Signal Delay so that the reject device operates just as the front edge of the pack reaches it.



- 6) Press the soft key adjacent to REJECT TIME.
- Place the metal contaminant at the rear / trailing edge of the product package.
  - Pass the product with the metal contaminant attached through the detector aperture, ensuring that the product does not slip or skew.
  - Use the cursor Up and Down keys to adjust the Reject Time in a way that would reject the pack if it was positioned correctly.



*We are not attempting to reject the product at this time !*

- 7) Press the Enter key to accept the new settings.
- 8) Press the Enter key a second time to proceed to the next display.

- 9) Press the soft key adjacent to YES.



# OPERATING INSTRUCTIONS

- 10) Ensure that the pack sensor beam is clear of any packs or products.
- 11) Select the soft key adjacent to WINDOW TIME. The display will show '-RUN-'.
- 12) Pass the product sample through the pack sensor beam, ensuring that it does not skew or slip on the conveyor.

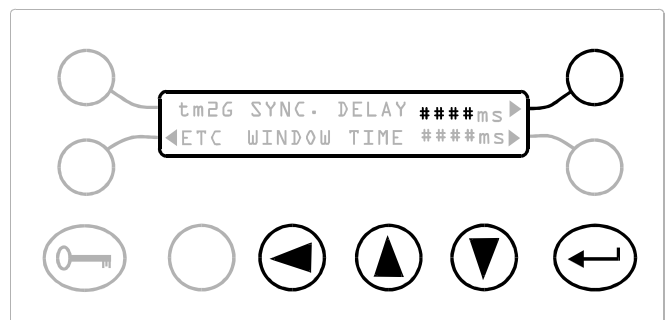
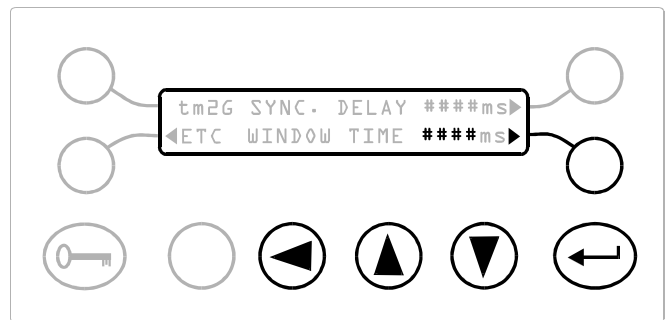
*The metal detector will automatically measure the window time and display this instead of the '-RUN-' message.*

- 13) Repeat steps 11) and 12) to ensure that the window time is being measured correctly and is repeatedly calculating the same value, (within  $\pm 10\%$ ).
- 14) Ensure that the pack sensor beam is clear of any packs or products.
- 15) Select the soft key adjacent to the SYNC. DELAY.

*When the Sync. delay is selected the detect led and buzzer will sound permanently.*

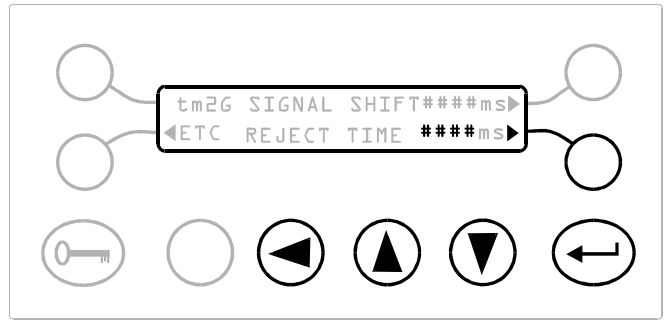
- a) Pass the product through the detector aperture, ensuring that the product does not slip or skew.
- b) Use the cursor Up and Down keys to adjust the Sync Delay so that the pack is rejected accurately and consistently.

- 16) Press the Enter key to accept the new settings.
- 17) Press the soft key adjacent to ETC.

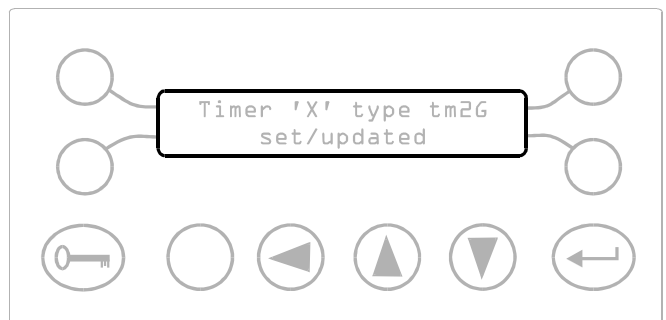


# OPERATING INSTRUCTIONS

- 18) Press the soft key adjacent to REJECT TIME.
    - a) Place the metal contaminant at the front or rear edge of the product package.
    - b) Pass the product with the metal contaminant through the detector aperture, ensuring that the product does not slip or skew.
    - c) Use the cursor Up and Down keys to adjust the Reject Time until the pack is rejected accurately and repeatedly.
  - 19) Press the Enter key to accept the new settings.
  - 20) Press the Enter key a second time to proceed to the next display.
- 



- 21) The display shown opposite will appear for five seconds before returning to the Engineer Mode display.



## Testing the Reject Device.

- 22)
  - a) Check the setting of tm2G by passing the product and metal contaminant through the aperture of the detector.
  - b) Check the reject device operates correctly with the metal contaminant at both the front and rear of the pack.
  - c) Check the reject device operates correctly with different sizes of metal contaminant.

Under normal operating conditions with packs continuously passing along a conveyor if the gap between a metal contaminated pack and the adjacent pack is less than half the pack length both packs may be rejected.

- 23) If for any reason the calibration of the tm2G timer is not correct return to step 1) and repeat all the steps.

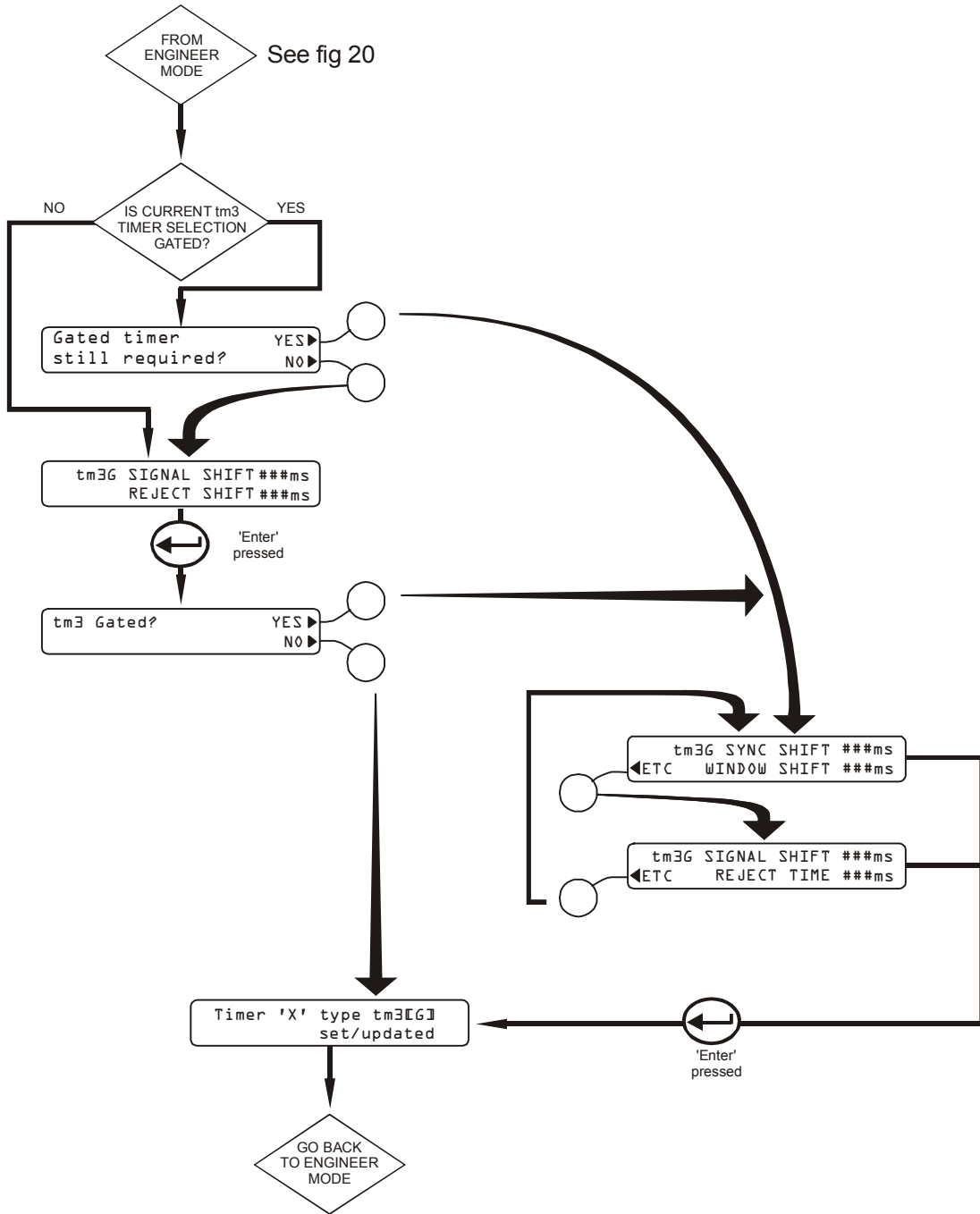


Fig 23 Tm3 Timer Flow Chart

## tm3[G] TIMER - NON GATED MODE



CAUTION

Ensure you have read the **REJECT TIMERS INTRODUCTION** section on page 78

### Introduction

The tm3 timer is used on variable speed product lines or product lines that may be stopped or started by external equipment.

The tm3 timer when used in the non-gated mode is ideal for use with loose product where the reject device is situated some distance from the detector.

This timer is also suitable for use with packaged products but is not as accurate as the gated version, tm3G.



NOTE

**Remember to record all settings on the Settings Sheets at the rear of the manual.**

This timer type is suitable for reject devices which include plough-action diverters, retracting bands etc.



NOTE

### EXPLANATORY NOTE

The tm3 and tm3G timer modes continually refer to terms such as 'SIGNAL SHIFT', 'REJECT SHIFT', 'SYNC SHIFT' etc. The word shift when used in these context refers to the distance the product will move (or shift) between successive pulses on the speed sensor input. Thus if a speed sensor has a shift of 10 cm then a REJECT SHIFT of 5 is equivalent to a product moving a distance of  $5 \times 10 \text{ cm} = 50 \text{ cm}$ .

*For instructions on calculating the shift distance for your application refer to Appendix A.*

### tm3 settings

#### 1) Signal Shift

This is the number of speed sensor pulses taken for a metal contaminant to travel from the detector to the reject device.

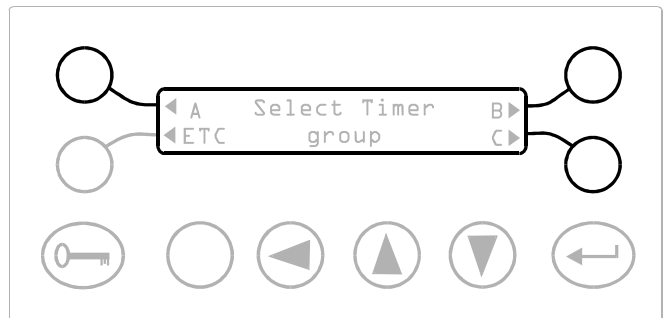
#### 2) Reject Shift

This is the number of speed sensor pulses required by the reject device to reject the contaminated product.

### Setting up Timer Type tm3

The display opposite may be used to either:

- 1) Select which timer group the current product number should use,
- or,
- 2) Select which timer group the current product number should use AND adjust the timer group settings such as timer type, reject shift, signal shift etc.



The currently selected timer group will be indicated by a flashing cursor appearing over the group letter.



NOTE

### REMINDER

If you have already selected the timer group and pressed YES to updating the group, as per the Engineer Mode section earlier, then proceed to step 3).

- 1) Press the soft key adjacent to the required group letter, A, B or C.

# OPERATING INSTRUCTIONS

- 2) If you only need to select the timer group for the current product number and not adjust any of the timer group properties then

- a) Select the soft key adjacent to NO, and go back to the Engineer Mode section.



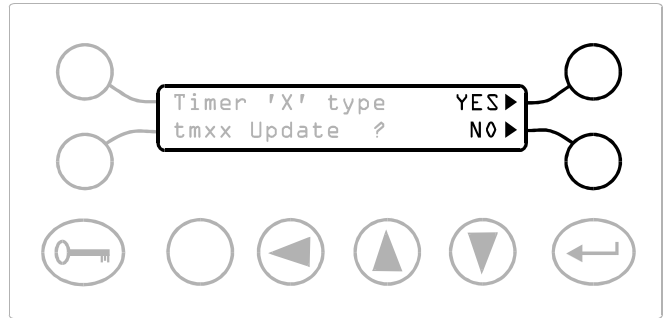
## CAUTION

Although NO was selected the group will be changed to the group letter selected in 1).

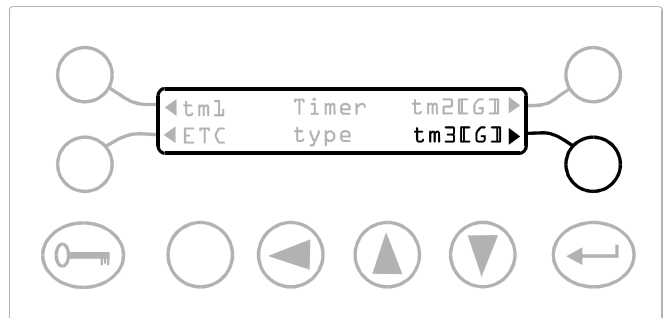
else

- b) Select the soft key adjacent to YES, and proceed to step 3).

In the following displays 'X' represents the timer group A, B or C as selected at step 1); tmxx represents the timer type that is currently selected for this timer group.



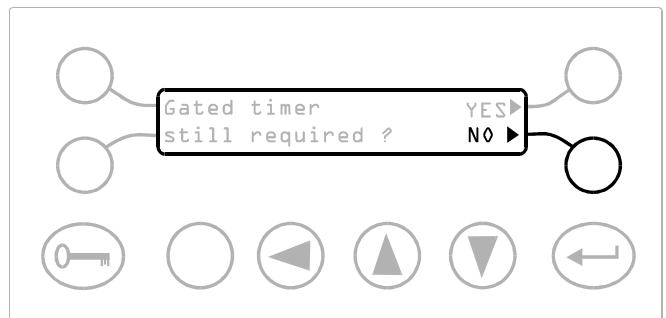
- 3) Press the soft key adjacent to tm3[G].



- 4) a) If the display opposite appears, press the soft key adjacent to NO.

else

- b) Proceed to step 5).

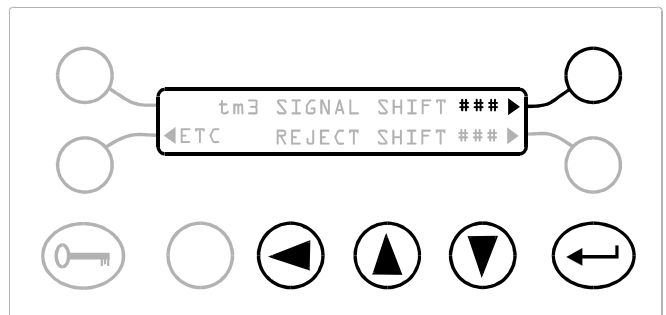


- 5) Set the product line to its mid range speed.

- 6) Press the soft key adjacent to SIGNAL SHIFT.

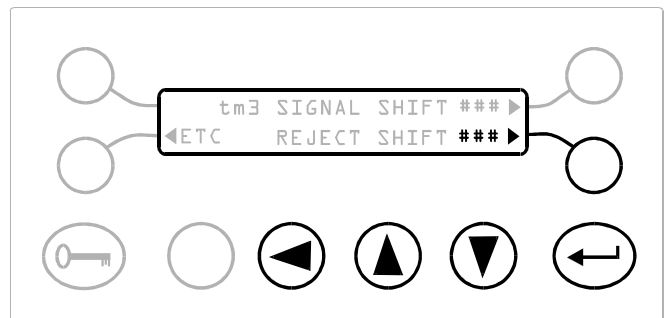
- a) For packaged or separate products

- 1 Place the metal contaminant at the rear /trailing edge of the product.
- 2 Pass the product with the metal contaminant attached through the detector aperture, ensuring that the product does not slip or skew.
- 3 Use the cursor Up and Down keys to adjust the Signal Shift so that the reject device operates as the front edge of the pack reaches it.



# OPERATING INSTRUCTIONS

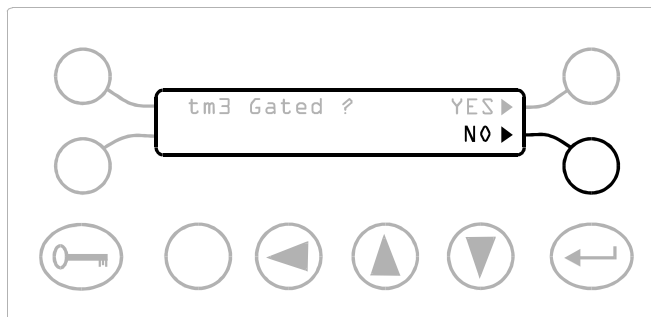
- b) For loose products
  - i) Place the metal contaminant on the centre of the conveyor belt.
  - ii) Pass the product with the metal contaminant attached through the detector aperture.
  - iii) Use the cursor Up and Down keys to adjust the Signal Shift so that the reject device operates just as the metal contaminant reaches it.
- 7) Press the soft key adjacent to REJECT SHIFT.
  - a) For packaged or separate products
    - i) Place the metal contaminant at the front /leading edge of the product.
    - ii) Pass the product with the metal contaminant through the detector aperture, ensuring that the product does not slip or skew.
    - iii) Use the cursor Up and Down keys to adjust the Reject Shift so that the metal contaminant is rejected consistently and accurately.
  - b) For loose products
    - i) Place the metal contaminant on the centre of the conveyor belt.
    - ii) Pass the product with the metal contaminant through the detector aperture.
    - iii) Use the cursor Up and Down keys to adjust the Reject Shift so that the metal contaminated product contaminant is rejected with the minimum of wasted product.
- 8) Press the Enter key when the required value has been set.
- 9) Press the Enter key a second time to proceed to the next display.





# OPERATING INSTRUCTIONS

10) Press the soft key adjacent to NO



11) The display shown opposite will appear for five seconds before returning to the Engineer Mode display.



## Testing the Reject Device.

12)

- a) For packaged or separate products
  - i) Check the setting of tm3 by passing the product and metal contaminant through the aperture of the detector.
  - ii) Check the reject device operates correctly with the metal contaminant at both the front and rear of the pack.
  - iii) Check the reject device operates correctly with different sizes of metal contaminant.
  - iv) Repeat i) to iii) above at the lowest and highest speeds.

# OPERATING INSTRUCTIONS

- b) For loose products
  - i) Check the setting of tm3 by passing the product and metal contaminant through the aperture of the detector.
  - ii) Check the reject device operates correctly with the metal contaminant at different positions on the conveyor belt.
  - iii) Check the reject device operates correctly with different sizes of metal contaminant.
  - iv) Also check the reject device operates correctly with two metal contaminants spaced at different distances apart on the conveyor belt.
  - v) Repeat i) to iv) above at the lowest and highest speeds.
  
- 13) If for any reason the setting of the tm3 timer is not correct return to step 1) and repeat all the steps.

## tm3[G] TIMER - GATED MODE



CAUTION

**Ensure you have read the REJECT TIMERS INTRODUCTION section on page 78**

### Introduction

The tm3G timer is used on variable speed product lines or product lines that may be stopped or started by external equipment.

The tm3G gated timer is used to give precise rejection of packaged or individual products.

The use of gating via a pack sensor ensures that the rejection is independent of the position or size of the metal contaminant.

This timer type is suitable for reject devices which include air-blast diverters, drop/lift flap diverters etc.



NOTE

**Remember to record all settings on the Settings Sheets at the rear of the manual.**



NOTE

### EXPLANATORY NOTE

The tm3 and tm3G timer modes continually refer to terms such as 'SIGNAL SHIFT', 'REJECT SHIFT', 'SYNC SHIFT' etc. The word shift when used in these context refers to the distance the product will move (or shift) between successive pulses on the speed sensor input. Thus if a speed sensor has a shift of 10 cm then a REJECT SHIFT of 5 is equivalent to a product moving a distance of  $5 \times 10 \text{ cm} = 50 \text{ cm}$ .

*For instructions on calculating the shift distance for your application refer to Appendix A.*

### tm3G settings

- 1) Signal Shift  
This is the number of speed sensor pulses taken for a metal contaminant to travel from the metal detector to the reject device.
- 2) Reject Time  
This is the time required by the reject device to reject the contaminated product.
- 3) Window Shift  
This number is equal to twice the number of speed sensor pulses a single pack takes to pass by the pack sensor  
  
This value is measured and calculated automatically by the detector during the timer setup.
- 4) Sync Shift  
This is the number of speed sensor pulses taken for the pack to travel from the pack sensor to the reject device.

# OPERATING INSTRUCTIONS

## Setting up timer type tm3G in gated mode

The display opposite may be used to either:

- 1) Select which timer group the current product number should use,
- or,
- 2) Select which timer group the current product number should use AND adjust the timer group settings such as timer type, reject time, signal shift etc.



NOTE

### REMINDER

If you have already selected the timer group and pressed YES to updating the group, as per the Engineer Mode section earlier, then proceed to step 3).

- 1) Press the soft key adjacent to the required group letter, A, B or C.
- 2) If you only need to select the timer group for the current product number and not adjust any of the timer group properties then
  - a) Select the soft key adjacent to NO, and go back to the Engineer Mode section.



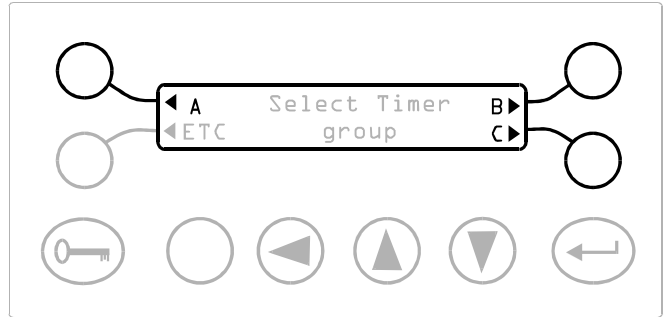
CAUTION

*Although NO was selected the group will be changed to the group letter selected in 1).*

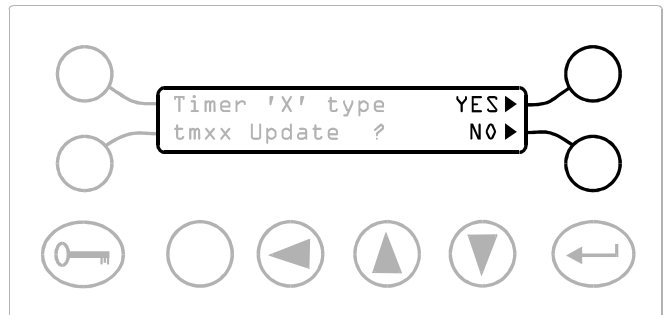
else

- b) Select the soft key adjacent to YES, and proceed to step 3)

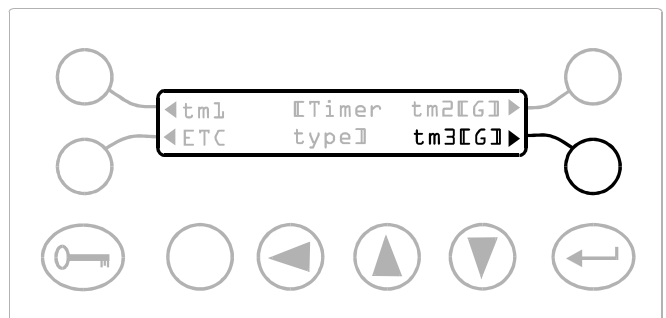
In the following displays 'X' represents the timer group A, B or C as selected at step 1); tmxx represents the timer type that is currently selected for this timer group.



The currently selected timer group will be indicated by a flashing cursor appearing over the group letter.



- 3) Press the soft key adjacent to tm3[G]

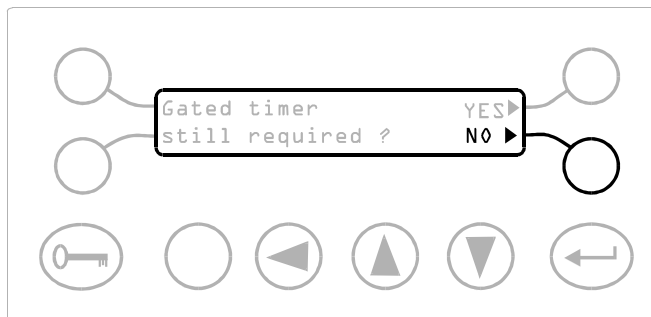


# OPERATING INSTRUCTIONS

- 4)  
a) If the display opposite appears, press the soft key adjacent to NO.

else

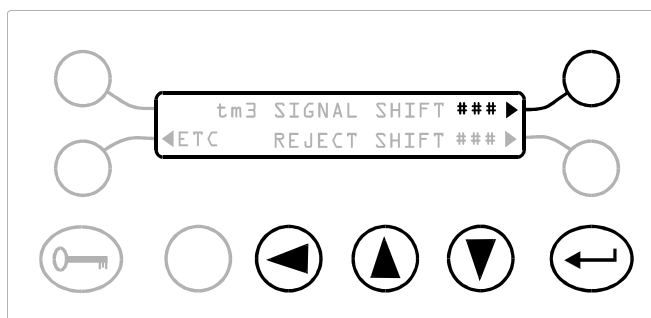
- b) Proceed to step 5).



- 5) Set the product line to its mid range speed.

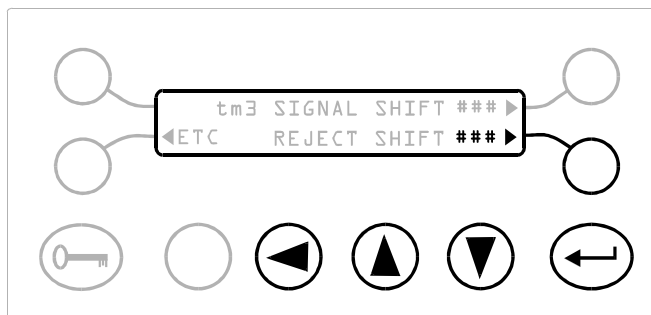
- 6) Press the soft key adjacent to SIGNAL SHIFT.

- a) Place the metal contaminant at the rear / trailing edge of the product.
- b) Pass the product with the metal contaminant attached through the detector aperture, ensuring that the product does not slip or skew.
- c) Use the cursor Up and Down keys to adjust the Signal Shift so that the reject device operates just as the front edge of the pack reaches the centre of the reject device.



- 7) Press the soft key adjacent to REJECT SHIFT.

- a) Place the metal contaminant at the rear / trailing edge of the product package.
- b) Pass the product with the metal contaminant attached through the detector aperture, ensuring that the product does not slip or skew.
- c) Use the cursor Up and Down keys to adjust the Reject Shift in a way that would reject the pack if it was positioned correctly.

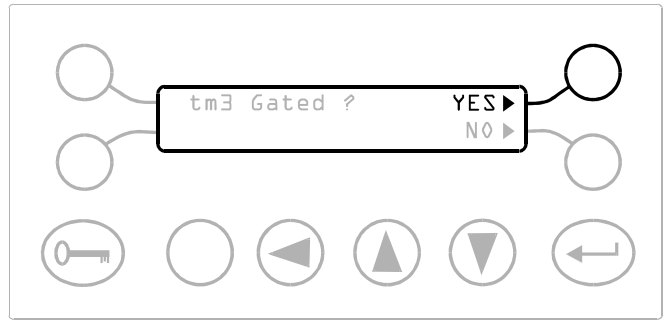


*We are not attempting to reject the product at this time !*

- 8) Press the Enter key to accept the new settings.
- 9) Press the Enter key a second time to proceed to the next display.

# OPERATING INSTRUCTIONS

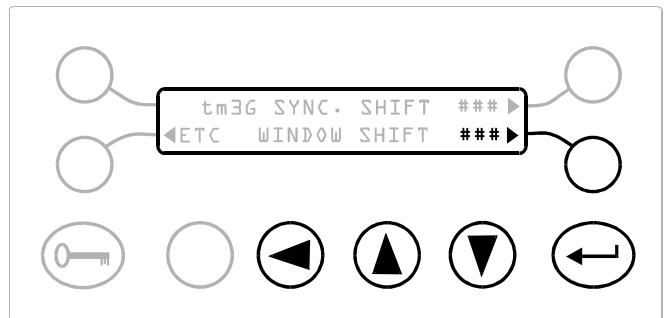
- 10) Press the soft key adjacent to YES.



- 11) Ensure that the pack sensor beam is clear of any packs or products.
- 12) Select the soft key adjacent to WINDOW SHIFT. The display should show '-RUN-'.
- 13) Pass the product sample through the pack sensor beam, ensuring that it does not skew or slip on the conveyor.

*The metal detector will automatically measure the window shift and display this instead of the -RUN- message.*

- 14) Repeat steps 12) and 13) to ensure that the window shift is being measured correctly and is repeatedly calculating the same value, (within  $\pm 10\%$ ).
- 15) Ensure that the pack sensor beam is clear of any packs or products.



# OPERATING INSTRUCTIONS

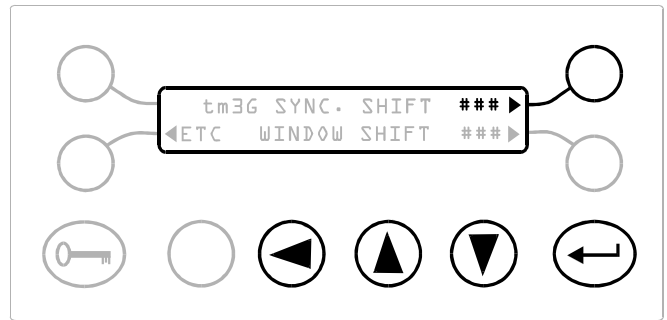
- 16) Select the soft key adjacent to the SYNC. SHIFT.

*When the Sync. Shift is selected the detect led will be lit and the buzzer will sound permanently.*

- Pass the product with the metal contaminant through the detector aperture, ensuring that the product does not slip or skew.
- Use the cursor Up and Down keys to adjust the Sync Delay so that the packs are rejected accurately and consistently.

- 17) Press the Enter key to accept the new settings.

- 18) Press the soft key adjacent to ETC.

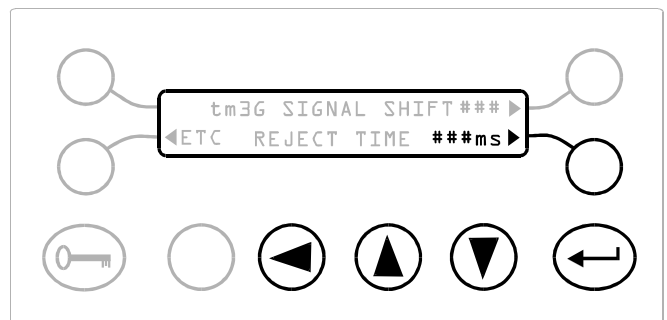


- 19) Press the soft key adjacent to REJECT TIME.

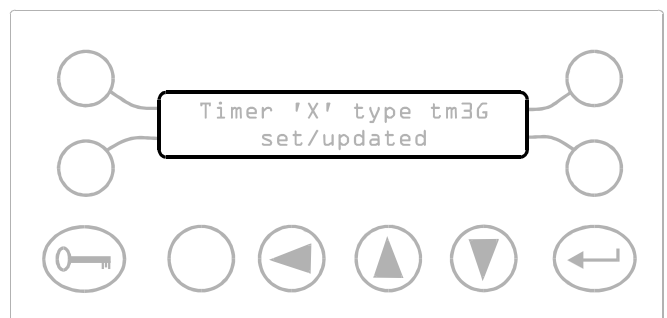
- Place the metal contaminant at the front or rear edge of the product package.
- Pass the product with the metal contaminant attached through the detector aperture, ensuring that the product does not slip or skew.
- Use the cursor Up and Down keys to adjust the Reject Time until the pack is rejected accurately and repeatedly.

- 20) Press the Enter key to accept the new settings.

- 21) Press the Enter key a second time to proceed to the next display.



- 22) The display shown opposite will appear for five seconds before returning to the Engineer Mode display



## Testing the Reject Device.

23)

- a) Check the setting of tm3G by passing the product and metal contaminant through the aperture of the detector.
- b) Check the reject device operates correctly with the metal contaminant at both the front and rear of the pack
- c) Check the reject device operates correctly with different sizes of metal contaminant.
- d) Repeat a) to c) above at the lowest and highest speeds.

24) If for any reason the calibration of the tm3G timer is not correct return to step 1) and repeat all the steps.



## REJECT CONFIRMATION UNIT

### Introduction

The Reject Confirmation Unit (RCU) on loose product applications confirms that the reject mechanism has responded at the correct time. On packaged product applications the RCU confirms that the contaminated product has been successfully rejected.



NOTE

The RCU can not be used on stop / start applications

The RCU achieves this by knowing when the Reject Mechanism is to be activated and deactivated. Following reject deactivation the RCU waits for a signal generated via the Reject Mechanism or the rejected product to confirm reject operation. This signal is produced by a suitably positioned sensor, called a Reject Confirmation (RC) Sensor.



NOTE

Remember to record all settings on the settings sheet at the rear of the manual.

### RC Sensor

The RC Sensor should be in one of two positions;

- a) On loose product applications the RC Sensor should confirm that the reject mechanism has reached its full reject position.
- b) On packaged product applications the RC Sensor should confirm that the product has entered the reject bin.

This arrangement is not practical with all packaged products. Certain pillar packs and pouches could not be reliably sensed entering the reject bin. If the pack type makes the sensing of it questionable, then the RC Sensor should be positioned as in a).

The RC Sensor under normal running conditions should have its output in a LOW state and change to a HIGH state when;

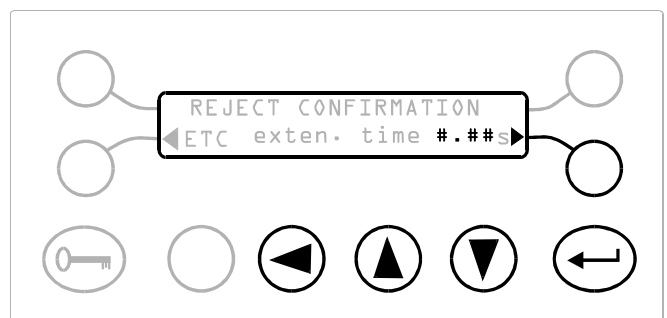
- a) on packaged product applications a rejected pack obscures the sensor or
- b) on loose product applications the reject mechanism has reached its full reject position.

### RCU Settings

Depending on the timer type selected one of two displays are available to allow the user adjustment.

#### Timer Types - tm1, tm2 and tm3

The detector needs to be told how long it must wait from releasing the Reject Mechanism, to receiving a signal from the RC Sensor. This period plus a small safety margin is known as the RC Extension time and must be entered by the user.



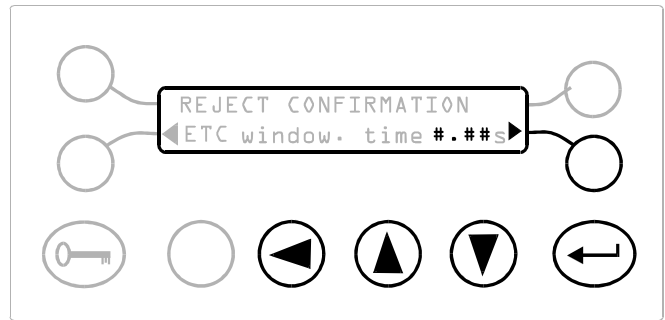
# OPERATING INSTRUCTIONS

## Timer Type - tm3 and tm3G

The detector needs to be told the time taken for a contaminated product to travel from the centre of the detector aperture to entering the reject bin. This period plus a small safety margin is known as the RC Window time and must be entered by the user.

### NOTE

The RC Window time must be set with the conveyor running at its slowest rate, to ensure proper operation over the rest of its variable speed range.



## Important Notes

- 1) The reject timer (i.e A, B or C) must have been set-up prior to adjusting the RC extension/window time
- 2) Small size metal contaminants (test samples) should be used to set the RC extension/ window time. The use of large test samples will produce errors in the setting. If this is not possible use the smallest test sample available and adjust the sensitivity so that the test sample gives an indication of 2 or 3 red bars on the bar graph display.
- 3) For packaged product position the test Sample on top of the pack at the front/leading edge.

## Loose Product, Fixed Speed Applications

- 1) From the running mode display press PROG/EXIT key.
- 2) Enter the Engineers security code.
- 3) Press ETC soft key until the Reject Confirmation display is reached.
- 4) Press the RC exten. time soft key.
- 5) Set the extension time to 100 ms.
- 6) Pass a test sample through the detector aperture to trigger the detector.  

The reject mechanism will respond according to its settings. When the reject mechanism is released and moves from reject back to the pass position the RC Sensor confirms reject operation, providing the extension time setting is long enough.
- 7) If the detector goes into a reject fault condition, increase the extension time by a further 100 ms.
- 8) Repeat step 6) and 7) until the detector signals no fault condition.

- 9) increase the extension time by 200 ms and press the ENTER key to enter the new value into memory

## Packaged Product, Fixed Speed Applications

- 1) From the running mode display press PROG/EXIT key.
- 2) Enter the Engineers security code.
- 3) Press ETC soft key until the Reject Confirmation display is reached.
- 4) Press the exten. time soft key.
- 5) Set the extension time to 100 ms.
- 6) Pass a pack containing the test sample through the detector aperture to trigger the detector.  

The reject mechanism will respond according to its settings. The rejected pack when leaving the conveyor or entering the reject bin will pass the RC sensor, which will confirm reject operation to the RCU providing the extension time setting is long enough.
- 7) If the detector goes in to a reject fault condition, increase the extension time by a further 100 ms

- 8) Repeat step 6) and 7) until the detector signals no fault condition.

## Loose Product, Variable Speed Applications

- 1) Set the line speed to its slowest speed.
- 2) From the running mode display press PROG/EXIT key.
- 3) Enter the Engineers security code.
- 4) Press ETC soft key until the Reject Confirmation display is reached.
- 5) Press the RC window time soft key.
- 6) Estimate the time taken for a contaminated product to travel from the centre of the detector aperture and enter the reject bin. Set the RC window time to this estimated value.
- 7) Pass a test sample through the detector aperture to trigger the detector.

The reject mechanism will respond in accordance with its settings and when released will move from its reject position back to the pass position. The RC Sensor should confirm reject operation to the RCU providing the RC window time setting is long enough

- 8) If the detector goes into a reject fault condition increase the RC window time by a further 500 ms.
- 9) Repeat steps 7) and 8) until the detector signals no fault condition.
- 10) Reduce the RC window time by 100 ms.
- 11) Repeat steps 7) and 9) until the detector signals a fault condition.
- 12) Increase the RC window time by 300 ms and press the ENTER key to enter the new value into memory.

## Packaged Product, Variable Speed Applications

- 1) Set the line speed to its slowest speed.
- 2) From the running mode display press PROG/EXIT key.
- 3) Enter the Engineers security code.
- 4) Press ETC soft key until the Reject Confirmation display is reached.
- 5) Press the RC window time soft key.
- 6) Estimate the time taken for a contaminated product to travel from the centre of the detector aperture and enter the reject bin. Set the RC window time to this estimated value.
- 7) Pass a pack containing the test sample through the Metal detector aperture to trigger the detector.

The reject mechanism will respond in accordance with its settings. The rejected pack whilst leaving the conveyor or entering the reject bin will pass the RC Sensor, confirming reject operation to the RCU providing the extension time setting is long enough.

- 8) If the detector goes into a reject fault condition increase the RC window time by a further 500 ms.
- 9) Repeat steps 7) and 8) until the detector signals no fault condition.
- 10) Reduce the RC window time by 100 ms.
- 11) Repeat steps 7) and 9) until the detector signals a fault condition.
- 12) Increase the RC window time by 300 ms and press the ENTER key to enter the new value into memory.

## RCU Fault Reporting.

The Module will display one of two RCU fault conditions.

The fault displays will be shown from the running mode display only, and will not prevent the Module from operating. To draw attention to the problem the buzzer will be driven.

---

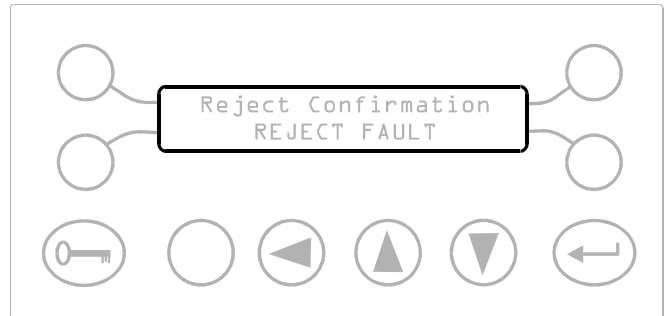
### Reject Fault.

This fault display indicates that the RCU has signalled a reject fault condition.

Assuming the RC extension window time has been set correctly, the fault condition could be due to either or both of the following;

- a) The Reject Mechanism has failed to operate or failed to operate at the correct time.
- b) The RC Sensor has not signalled the RCU to confirm reject operation.

The detector will clear the display when the RCU is reset.



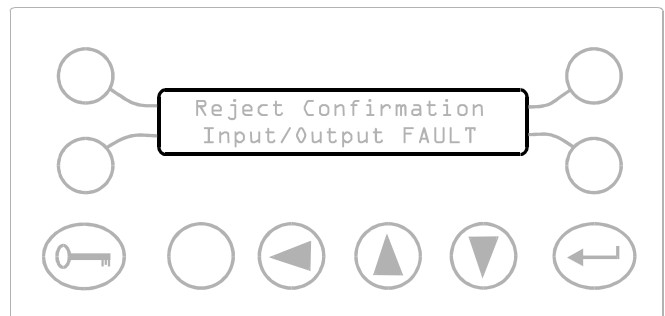
---

### Input/output Fault

This display indicates that a fault has occurred in the input output circuitry from the Module to the RCU, this could be a connection or I.C fault within the Detector Head or Module. It is more likely to be one of the following;

- a) The RCU cable connection from the Detector Head to the P/S Connection PCB is not connected correctly.
- b) The RCU board is not in situ.

The Module will not clear the display until the Detector Head is switched off.



## SPEED SENSOR FOR THE TM3 AND TM3[G] TIMERS

### Speed Sensor Requirements

The speed sensor may be:

- a) A purpose bought item, known as a Rotary Encoder,
- or
- b) A Proximity/Photo-electric sensor together with the necessary hardware to produce a pulse output from rotary movement.

In either case the device must be coupled up to the conveyor drive system to give a pulse output signal in direct relation to the distance moved by the conveyor.

The device chosen must have the following electrical specification:

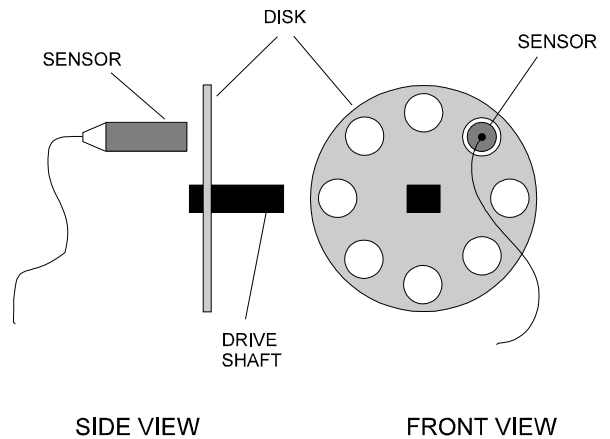
|  |                     |
|--|---------------------|
| Operating Voltage-   | +15 V D.C.          |
| Quiescent Current -  | 60 mA maximum.      |
| Output Type -  | NPN open collector. |
| PNP output devices can be accommodated by changing the internal link arrangement in the detector head.                   |                     |
| <b>Note</b>  |                     |
| If a pack sensor is also being used, both the pack sensor and the speed sensor must be the same output type, NPN or PNP. |                     |
| Output Voltage:-   | 15 V minimum.       |
| Output Current:-   | 10 mA minimum.      |
| Output Waveform:-  | Pulse output        |
| Pulse width:-  | 10 ms minimum.      |
| Frequency:-  | 50 Hz maximum       |

### Speed Sensor Electrical Connections

Refer to the Installation section.

Connect the sensor to the terminals labelled Speed Sensor.

### Producing A Rotary Encoder Using A Proximity or Photo-electric Sensor



**Fig 24 Rotary Encoder**

Figure A-1 above shows a possible technique for producing a rotary encoder using a proximity or photo-electric sensor.

The disk shown has been drilled so that the sensor will give a pulse output as the rotating disk intermittently interrupts its sensing area.

The sensor shown would typically be a proximity type and the disk would be fabricated from mild steel. Alternatively a two part photo-electric sensor could be used, i.e with separate transmitter and receiver or with combined transmitter and receiver and reflector.

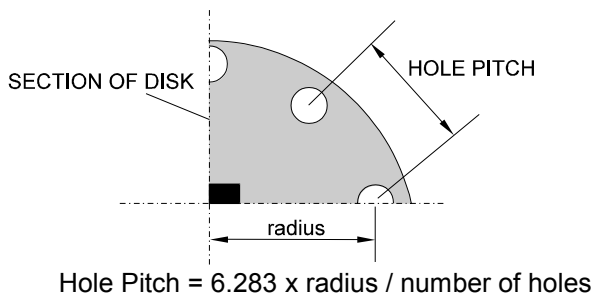
**Note**

Avoid the use of photoelectrics that require the disk itself to reflect the beam.

Both proximity and photo-electric devices are available in a slot sensor type construction, which can be mounted to sit astride the disk. If this technique is used the disk should be slotted rather than drilled.

## Disc Construction

The disk diameter and number of holes/slots can be determined when the required shift distance of the speed sensor is known (see following section). If the required shift distance is 25mm/shift then the hole/slot pitch of the disk should be designed so the sensor gives one pulse cycle out for 25mm moved by the conveyor, see Figure A-2 below.



**Fig 25 Disc Construction**

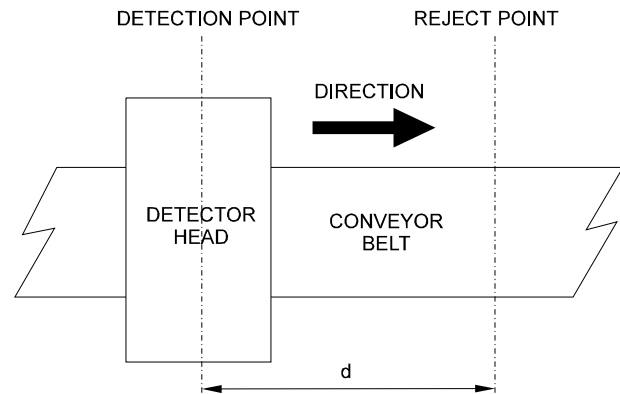
In building the disk, make sure that the solid and gap width are such as to keep the pulse width and frequency within the specified limits.

## Determining The Required Shift Distance Of The Speed Sensor

The speed sensor provides digital pulses in relation to the distance moved by the conveyor. The incremental distance moved between pulses is known as the SHIFT distance and is the smallest interval measurable by the detector (i.e. its resolution).

Table A-1 can be used to determine the shift distance for your system. Using distance, d, between the detection and rejection points

(see Figure A-3 below), follow these steps.



**Fig 26 Determining The Required Shift Distance**

- 1) Find the point on the table where d lies between the minimum and maximum limits. If this value lies at more than one point in the table select the point that corresponds to the smallest shift distance,

Example.

For, d = 1000 mm (39 inch)

This value lies at four points in the table, which corresponds to shift distances of 13 mm, 19 mm, 25.5 mm and 32 mm.

Select the smallest value, 13 mm (0.5 inch).

- 2) Next check that your maximum conveyor speed does not exceed the limit specified in the table.

Example.

For, d = 1000 mm (39 inch) and,  
Shift Distance = 13 mm (0.5 inch)

The maximum conveyor speed is 38 m/min (125 ft/min).

If your maximum conveyor speed exceeds this limit then choose the next point up, where in our example the shift distance is 19 mm. At this point distance d still lies within limits, and we have an improved maximum conveyor speed at the expense of a larger shift distance.

If your maximum conveyor speed still exceeds the tabulated limit then choose the next point up, providing, as in our example, distance d still lies within limits.

|  |         |                           |                          |                            |                          |                            |
|--|---------|---------------------------|--------------------------|----------------------------|--------------------------|----------------------------|
| Shift Distance                         |         | 6.5 mm<br>(0.25 inch)     | 13 mm<br>(0.5 inch)      | 19 mm<br>(0.75 inch)       | 25.5 mm<br>(1.0 inch)    | 32 mm<br>(1.25 inch)       |
| Detection to Rejection.<br>Distance, d | Minimum | 191 mm<br>(7.5 inch)      | 381 mm<br>(15 inch)      | 572 mm<br>(22.5 inch)      | 762 mm<br>(30 inch)      | 953 mm<br>(37.5 inch)      |
|  | Maximum | 635 mm<br>(25 inch)       | 1270 mm<br>(50 inch)     | 1905 mm<br>(75 inch)       | 2540 mm<br>(100 inch)    | 3175 mm<br>(125 inch)      |
| Maximum conveyor speed                 |         | 19 m/min<br>(62.5 ft/min) | 38 m/min<br>(125 ft/min) | 57 m/min<br>(187.5 ft/min) | 76 m/min<br>(250 ft/min) | 95 m/min<br>(312.5 ft/min) |

## SETTING UP AND CONNECTING A PRINTER TO THE METAL DETECTOR

### General

Information transmitted by the metal detector may be transferred directly to paper by using a printer.

Alternatively it may be collected by other types of 'intelligent' equipment such as a terminal computer.

This appendix is intended for users who wish to use their own printer or intelligent equipment. All references in this text assume a printer is being used, it applies however equally to any data collection device.

### Requirements Of Your Serial Printer

Currently the printer driver supplied as standard with the metal detector is designed to drive either a dot matrix type or an Epson TML60 II printer.

The format of the information being output by the metal detector is in columns of up to 42 characters.

The serial communication parameters of your printer must be setup as follows:

|               |      |   |            |
|---------------|------|---|------------|
| Baud rate :   | 9600 |   |            |
| Data bits :   | 8    | - | TML60 II   |
| printer       |      |   |            |
| printer       | 7    | - | Dot matrix |
| Start bits :  | 1    |   |            |
| Stop bits :   | 1    |   |            |
| Parity bits : | 1    |   | Odd        |

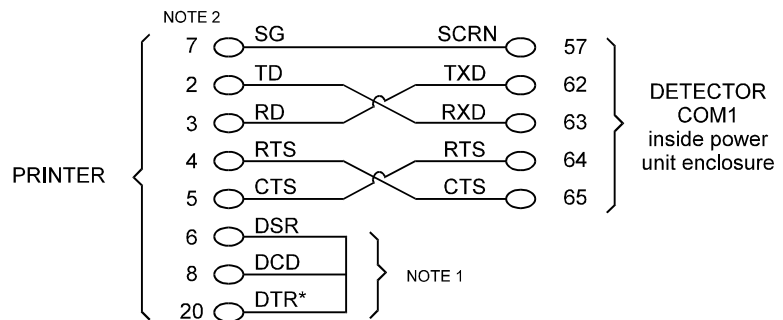
The printer ideally will use hardware handshaking although X-ON and X-OFF software handshaking is supported but must be selected from the Engineer mode.

See Printer Handshake (page 47)

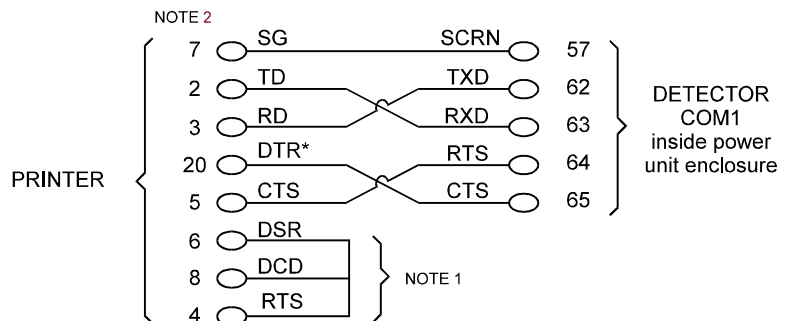


## Connection of Printer to Detector

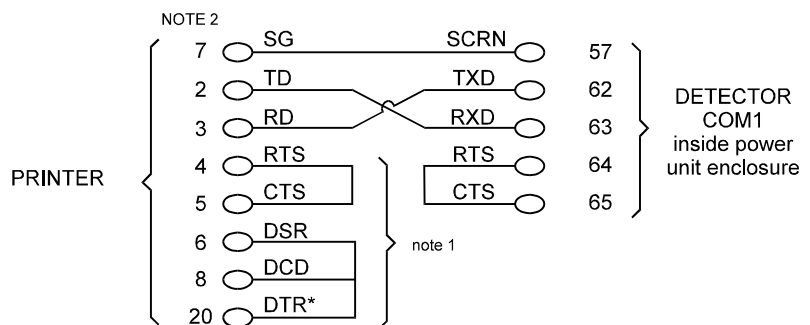
1) Hardware handshake connection (recommended)



2) Hardware handshake connection (printer does not use RTS line)



3) Software handshake connection for X-ON/X-OFF control



\* Certain printers use SSD (pin 11) as an alternative printer-ready line.

### NOTES

- 1) Certain printers do not require CTS, DSR or DCD to be at active levels. However it is accepted good practice to connect these signals together as shown.
- 2) The printer pin numbers shown are for an RS232 25-way D-type connector - if your printer uses a 9 way D-type connector consult the printer manual for the correct pin numbers.

## SAMPLE PRINTED REPORTS

Note: Individual printouts will vary according to the settings stored in the metal detector

### Metal Detector Current Settings Printout

```

** SETTINGS**

Date      Time
01 Feb 96 13:41:47

Serial No      ; 0000
Machine ID     ; 110303
Line ID        ; 0000

*Detector Settings*

Prod  Name
00  NAME..... 00
01  NAME..... 01
02  NAME..... 02
03  NAME..... 03
04  NAME..... 04
05  NAME..... 05
06  NAME..... 06
07  NAME..... 07
08  NAME..... 08
09  NAME..... 09
10  NAME..... 10
11  NAME..... 11
12  NAME..... 12
13  NAME..... 13
14  NAME..... 14
15  NAME..... 15
16  NAME..... 16
17  NAME..... 17
18  NAME..... 18
19  NAME..... 19
20  NAME..... 20

Prod  Sens  Phase  Timer
00    170  000.00  A
01    170  000.00  A
02    170  000.00  A
03    170  000.00  A
04    170  000.00  A
05    170  000.00  A
06    170  000.00  A
    
```

```

07    170  000.00  A
08    170  000.00  A
09    170  000.00  A
10    170  000.00  A
11    170  000.00  A
12    170  000.00  A
13    170  000.00  A
14    170  000.00  A
15    170  000.00  A
16    170  000.00  A
17    170  000.00  A
18    170  000.00  A
19    170  000.00  A
20    170  000.00  A

Prod Freq  Inverse  Power  P.S.C. Tracking
00  1      NO      HIGH  ---  ---
01  1      NO      HIGH  NO  NO
02  1      NO      HIGH  NO  NO
03  1      NO      HIGH  NO  NO
04  1      NO      HIGH  NO  NO
05  1      NO      HIGH  NO  NO
06  1      NO      HIGH  NO  NO
07  1      NO      HIGH  NO  NO
08  1      NO      HIGH  NO  NO
09  1      NO      HIGH  NO  NO
10  1      NO      HIGH  NO  NO
11  1      NO      HIGH  NO  NO
12  1      NO      HIGH  NO  NO
13  1      NO      HIGH  NO  NO
14  1      NO      HIGH  NO  NO
15  1      NO      HIGH  NO  NO
16  1      NO      HIGH  NO  NO
17  1      NO      HIGH  NO  NO
18  1      NO      HIGH  NO  NO
19  1      NO      HIGH  NO  NO
20  1      NO      HIGH  NO  NO

Timer Group ; A
Type        ; TM1
Reject Time ; 100ms
    
```

Printout (Continued)

```

Timer Group ; B
Type ; TM2
Reject Time ; 100ms
Sig Delay ; 200ms

Timer Group ; C
Type ; TM3
Reject Shift ; 100
Sig Shift ; 010

Ref Phase 1 ; -18.66
Ref Phase 2 ; -17.34
Buzzer ; ON
Pack sensor ; YES
Sensor distance ; 1000 mm
Speed range ; NORMAL
Product speed ; 001.0 m/min
Reject Inhibit ; NO
Reject confirm ; YES
Reject confirm ; 1000 ms
Auto. Track rate ; 2.00
Auto. Track span ; 30.00
Auto. Track damp ; 5
Boost ; NO
Printer handshake ; SW
Current
Prod No ; 00
    
```

QA Settings Printout

\* QA Settings \*

```

Line ID ; 0000
Printer ; YES
Printer ; FIXED
Relay Rpt ; YES
Settings Rpt ; YES
Report Int ; 00:00
Test Int ; 0:00
Overdue Int ; 0:00
Alarm ; DUE

Prod No Fe N/Fe S/S
00 0.0 0.0 0.0
01 0.0 0.0 0.0
02 0.0 .0.0 0.0
03 0.0 .0.0 0.0
04 0.0 .0.0 0.0
05 0.0 .0.0 0.0
06 0.0 .0.0 0.0
07 0.0 .0.0 0.0
08 0.0 .0.0 0.0
09 0.0 .0.0 0.0
10 0.0 .0.0 0.0
11 0.0 .0.0 0.0
12 0.0 .0.0 0.0
13 0.0 .0.0 0.0
14 0.0 .0.0 0.0
15 0.0 .0.0 0.0
16 0.0 .0.0 0.0
17 0.0 .0.0 0.0
18 0.0 .0.0 0.0
19 0.0 .0.0 0.0
20 0.0 .0.0 0.0
    
```

**Shift Report Printout**

```

** SHIFT REPORT START **
Line ID      ; 0000
Date        Time
21 Oct 95   10:30:15

*Reject Relay Operated*

Date        Time
21 Oct 95   09:00:45
21 Oct 95   09:00:45
21 Oct 95   09:00:46
21 Oct 95   09:00:47
21 Oct 95   09:00:48
21 Oct 95   09:31:03
21 Oct 95   10:05:59
21 Oct 95   10:06:00

*Modified Settings*

Date        Time
21 Oct 95   09:01:15

Prod No     ; 01
Sens       ; 180
Timer      ; C

Rej Count   ; RESET

Pack Count  ; RESET

Current
Prod No     ; 00
    
```

```

Date        Time
21 Oct 95   10:25:15

Prod No     ; 02
Sens       ; 185
Timer      ; A
Reject Inh  ; YES

Current
Prod No     ; 01

Date        Time
21 Oct 95   10:27:46

Reject Inh  ; NO

Current
Prod No     ; 01

**SHIFT REPORT END**
    
```

**Performance Check Printout**

\* Performance Check \*

Date            Time  
21 Jan 95      10:45:00

Line ID ; 0205

Operator        ; QA INSPECTOR

Prod No        ; 01

Sens            ; 156

Phase ; 05.00

Timer          ; B

Material; FERROUS

Size            ; 1.5mm

Dtection        ; YES

Reject Rly     ; YES

Result ; PASSED

Material; STAINLESS STEEL

Size            ; 1.5mm

Detection       ; YES

Reject Rly     ; YES

Result ; PASSED

# METAL DETECTOR SERIAL COMMUNICATIONS LINK

## Introduction

This link is a three wire serial connection allowing information to be transferred to and from the detector. Via the link it is possible for a host to monitor and change the detector settings, using a predefined set of commands. The information obtained in this way may be used for Quality Control and Assurance records.

## Host computer or intelligent equipment

The equipment to which the detector is connected must be programmed to recognise the received data which is in a strict format and protocol. Information transmitted from the host to the detector must also be in the same format and protocol for the detector to respond.

## Specification of the serial link.

This is specified in accordance with the ISO 'Open-Systems-Interconnection' (OSI) layered model for communications systems.

### Physical layer specification (OSI layer 1)

The physical layer is based on the RS232 voltage levels.

3 wire connection with no hardware flow control.

1 start bit

7 data bits

1 odd parity bit

1 stop bit

Transmission rate 9600 baud

Note.

The maximum recommended RS232 cable length is 15 meters.

### Data-link layer specification (OSI layer 2)

Here is the message representation as seen at the output of the data-link layer :-

(STX)G(VALUE)M(VALUE)(COMMAND)[(COMMAND)...](ETX)(CRC)

1. The message starts with STX (HEX 02) indicating start of message.
2. G and M are identifiers that are contained in every message.
3. (COMMAND) is made up of (IDENTIFIER)(VALUES LIST).  
(IDENTIFIER) is one of a series of letter or letter-number combinations detailed in the tables below.  
(VALUES LIST) are decimal values, with leading-zero suppression (unless otherwise specified), separated by comma's and terminated by the next command or ETX.  
Note that more than one (COMMAND) may be sent in a single message.
4. The message ends with ETX (HEX 03) indicating end of message.
5. This is followed by a cyclic redundancy code (CRC) of the characters contained between STX and ETX inclusive. Transmitted as a 4 digit hexadecimal number with leading zeros, high nibble first. See separate "CRC Generation".

On receiving a good packet of information the response of the receiving equipment is to send an ACK (HEX 06). See figures D-1 to D-6.

On receiving a bad packet of information the response of the receiving equipment is to send a NAK (HEX 15).

Packets of information may be initiated by the Host at any time the serial link is idle. The serial link's idle state is when any prior messages have been completed including all outstanding acknowledgements or timeouts.

Up to 10 retransmissions will be attempted if a NAK is received after each transmission. If no Acknowledgement is made or received the retransmission will occur after a timeout period of 250 milliseconds. Again up to 10 retransmissions will be attempted.

All data is represented as ASCII characters.

### Application layer specification (OSI layer 7)

The application layer operation can be split into various types of messages :-

#### 1. Event driven messages.

These messages are prompted by an event occurring inside the detector. These events can be one of the following list and are given in their order of priority when passed to the data-link layer for transmission :-

- a) Faults, extended faults (see command identifiers 'e' & 'F').
- b) Signal Transmissions, ('A'n and 'R'n when enabled by 'g'0 command).
- c) Logins using a security code at the keypad / Logout via PROG/EXIT key (or time out).
- d) Reserved for future development.
- e) Detector settings altered at the keyboard by an operator.
- f) Detector settings altered by a communications command.

#### 2. Host commands.

These are messages, initiated by the host, to change the settings of the detector or to read the settings of the detector.

#### 3. Detector responses to host commands.

#### 4. These messages are responses to host commands, and are sent by the detector.

If, in the unlikely case of the serial output buffers being filled, higher priority messages will be transmitted at the expense of lower priority messages.

### Test Mode

For the purpose of checking the serial link, the detector will double echo any character sent as long as the serial link is idling. The following character should not be sent, as they are recognised as part of a normal communication transmission:- STX, ACK, NAK.

### Priority of Host-Computer Vs Detector

The Host Computer or Intelligent equipment always takes priority over the detector when changing detector settings. If the user is logged into the detector via its control panel and the Host Computer or Intelligent equipment changes one of the detectors settings, the detector will be forced to log off and return to its running mode display.

## Valid message identifiers

Table D-1 Table of identifiers

| Command <sup>1 2</sup>          | Direction <sup>3</sup> | Description   | Type <sup>4</sup> |
|---------------------------------|------------------------|---|-------------------|
| 'A' m                           | out                    | Bargraph reading<br>m = A signed number representing the value being sent to the bargraph of the detector. A four digit number in the range $[\pm 0..2047]$ . <sup>5</sup>  | X                 |
| 'a' n                           | in/out                 | Operator access<br>n = 0 : LIMITED<br>n = 1 : FULL  | X                 |
| 'a?'                            | in                     | Operator access ?   |                   |
| 'B' n                           | in/out                 | Buzzer enable<br>n = 0 : NO<br>n = 1 : YES  | X                 |
| 'B?'                            | in                     | Buzzer enable ?   |                   |
| 'b'                             | -----                  | SEE LATER FOR DETAILS OF IDENTIFIER 'b'   | X                 |
| 'C' n ',' s1 ',' c1<br>'t ',' a | in/out                 | Preset Product Settings.<br>n = Product number, two digit number, in the range [0..20]<br>s1 = Sensitivity, three digit number, in the range [0..199]<br>c1 = Phase setting, five digit fixed point number, in the range [000.00 ... 180.00], resolution is 0.02.<br>t = Timer group<br>t = 0 : Timer group A<br>t = 1 : Timer group B<br>t = 2 : Timer group C<br>a = Frequency offset , single digit number in the range [0..1].<br><br>Note. If parameter n is 0 then c1 must be 00.00 | P                 |
| 'C?' n                          | in                     | Product Settings ?  |                   |
| 'c' n                           | in/out                 | Printer Handshake<br>n = 0 : HW<br>n = 1 : SW   | X                 |
| 'c?'                            |                        | Printer Handshake?  |                   |
| 'D' d ',' c                     | out                    | Counter values.<br>d = reject counter, four digit number, in the range [0..9999]<br>c = pack counter, eight digit number, in the range [0..16777214]  | X                 |
| 'D' d ',' c                     | in                     | d = 1 : Reset reject counter<br>c = 1 : Reset pack counter  |                   |
| 'D?'                            | in                     | Counter Values ?  |                   |
| 'd' s ',' m                     | out                    | Serial number and Model number of the detector.<br><br>s = Head serial number of the device, five digit number, in the range [0..65535].<br><i>s is read only, any value transmitted to the detector is ignored.</i><br><br>m = Model number of the device, a six digit number.<br>Note: Only the last five digits can be set by the host. The first digit is ignored by the detector when received.<br>(See instruction manual for details of this number)                               | F                 |
| 'd?'                            | in                     | Serial and model number ?   |                   |
| 'E'                             | -----                  | SEE LATER FOR DETAILS OF IDENTIFIER 'E'   | X                 |



| Command <sup>1,2</sup> | Direction <sup>3</sup> | Description   | Type <sup>4</sup> |
|------------------------|------------------------|---|-------------------|
| 'e' n ',' o            | out                    | <p>Extended-fault codes</p> <p>n : A sum of some of the following numbers when the extended-faults are present.</p> <p>n = 0 : No extended-fault reported , ( transmitted when last extended-fault clears, <u>or</u> on request with the 'e?' identifier if no extended-faults are present).</p> <p>n = 1 : FAULT 01</p> <p>n = 2 : FAULT 02</p> <p>n = 4 : <i>Reserved for future development.</i></p> <p>n = 8 : FAULT 03</p> <p>n = 16 : FAULT: Phase value out of limits.</p> <p>n = 32 : FAULT 05</p> <p>n = 64 : CAUTION: Date/time not set up.</p> <p>n = 128 : Overdue for performance check.</p> <p>n = 256 : Request for performance check.</p> <p>n = 512 : Inverse-detect must be deselected.</p> <p>n = 1024 : Timer must be gated for this option.</p> <p>n = 2048 : FAULT: Pack sensor blocked.</p> <p>n = 4096 : CAUTION: Pack sensor not selected.</p> <p>n = 8192 : Ensure no product is passing the pack sensor.</p> <p>n = 16384 : CAUTION: Auto. tracking disabled.</p> <p>n = 32768 : Power drive failed.</p><br><p>o = 1 : CAUTION: P.S.C has been disabled.</p> <p>o = 2 : P.S.C. not captured, use the automatic setup.</p> <p>o = 4 : CAUTION: Stored signal cleared.</p> <p>o = 8 : WARNING: Vibration is too high.</p> <p>o = 16 : P.S.C. not available with variable speed.</p> <p>o = 32 : Automatic tracking is not available with variable speed.</p> | X                 |
| 'e' n                  | in                     | <p>Acknowledge the extended fault code n.</p> <p>n : A sum of some of the following numbers when the extended-faults are present, [1,2,4,8,16,32,64] where these numbers correspond to an error number given above.</p>   |                   |
| 'e?'                   | in                     | Current extended-fault codes ?  |                   |

| Command <sup>1 2</sup> | Direction <sup>3</sup> | Description   | Type <sup>4</sup> |
|------------------------|------------------------|---|-------------------|
| 'F' n                  | out                    | <p>Fault Codes</p> <p>n : A sum of some of the following numbers when the faults are present.</p> <p>n = 0 : No faults reported , (transmitted when last fault clears, <u>or</u> on request with the 'F?' identifier if no faults are present).</p> <p>n = 1 : Balance fault - CONTACT SUPPLIER.</p> <p>n = 2 : FAULT 08</p> <p>n = 4 : FAULT 09</p> <p>n = 8 : <i>Reserved for future development.</i></p> <p>n = 16 : WARNING 02</p> <p>n = 32 : WARNING 03</p> <p>n = 64 : WARNING 04</p> <p>n = 128 : EPROM checksum fault.</p> <p>n = 256 : Reject Confirmation, Reject error.</p> <p>n = 512 : Reject Confirmation, Input/Output error.</p> <p>n = 1024 : Data collection unit not ready.</p> <p>n = 2048 : Data Collection unit not configured.</p> <p>n = 4096 : WARNING 07</p> <p>n = 8192 : Balancing - please wait.</p> <p>n = 16384 : <i>Reserved for future development.</i></p> <p>n = 32768 : One or possibly more extended-faults are present, use the 'e?' command to ascertain which extended-faults are present.</p> | X                 |
| 'F?'                   | in                     | Current fault status ?  |                   |
| 'f' m ', n             | in/out                 | <p>Inverse detect</p> <p>m = product number, a two digit number in the range [0..20]</p> <p>n = 0 : NO</p> <p>n = 1 : YES</p>   | P                 |
| 'f?' m                 | in                     | Inverse detect (for product number m) ?   |                   |
| 'G' n                  | in/out                 | <p>Message Length</p> <p>The number of characters, (or bytes), from after 'G'n to (but excluding) ETX in every communications message.</p> <p>n = A two digit number with leading zeroes, in the range [0..99].</p> <p>For example, the host transmission of the 'a?' command. The message format, (assuming XXXX = 4 digit message number), would be :-</p> <p>(STX)<b>G</b>07MXXXXa?(ETX)(CRC)</p> <p>where:</p> <p><b>G</b> is the message length identifier, and where n=<b>07</b> is the total number of characters in the 'MXXXXa?' part of the message.</p>  | X                 |
| 'g' n                  | in/out                 | <p>Bargraph and detection comms switch</p> <p>n = 0 : Disable the 'A'n and 'R'n identifiers from automatic transmission</p> <p>n = 1 : Enable the 'A'n and 'R'n identifiers for automatic transmission</p>  | X                 |
| 'g?'                   | in                     | Bargraph Comms switch ?   |                   |
| 'H' n                  | in/out                 | <p>Speed setting.</p> <p>n = 0 : NORMAL speed</p> <p>n = 1 : VARIABLE speed</p> <p>n = 2 : FAST speed</p> <p>n = 3 : Reserved for future development</p>  | X                 |
| 'H?'                   | in                     | Speed setting ?   |                   |

| Command <sup>1,2</sup> | Direction <sup>3</sup> | Description  | Type <sup>4</sup> |
|------------------------|------------------------|--|-------------------|
| 'h' n                  | in/out                 | Power-on / Reset flag<br>n = 0 : Flag is reset<br>n = 1 : Flag is set.<br>Note. This flag is <b>set</b> immediately after reset or power-on and is only reset by the host sending the command, 'h0'.   | <b>X</b>          |
| 'h?'                   | in                     | Power-on / Reset Occurred ?  |                   |
| 'I' n                  | in/out                 | Reject Inhibit<br>n = 0 : NO<br>n = 1 : YES  | <b>X</b>          |
| 'I?'                   | in                     | Reject Inhibit ?   |                   |
| 'J' n                  | in/out                 | Reject Confirmation.<br>n = 0 : NO<br>n = 1 : YES  | <b>X</b>          |
| 'J?'                   | in                     | Reject Confirmation ?  |                   |
| 'j'                    | -----                  | <i>SEE LATER FOR DETAILS OF IDENTIFIER 'j'</i>   |                   |
| 'K' n                  | in/out                 | Reject Confirmation (Extension or Window) time.<br>n = Reject Confirmation window time, a four digit number in the range [100...9900] - with timer types tm1, tm2 and tm2G, [0 60000] - with timer types tm3 and tm3G, (all times in milliseconds).                            |                   |
| 'K?'                   | in                     | Reject Confirmation (Extension or Window) time ?   |                   |
| 'L' n, o               | in/out                 | Power high/low setting<br>n = product number, a two digit number in the range [0..20].<br>o = 0: LOW<br>n = 1: HIGH  | <b>P</b>          |
| 'L?' o                 | in                     | Power high/low setting?  |                   |
| 'M' n                  | in/out                 | Message number.<br>n = A four digit number, with leading zeroes, in the range [0..9999].<br>This number is incremented for each message sent, (wraparound to zero). The detector will treat consecutive messages with the same message number as being a repeat of each other. | <b>X</b>          |
| 'N' n                  | in/out                 | Language<br>n = 0 : English<br>n = 1 : French<br>...<br>n = 8 : Japanese   | <b>X</b>          |
| 'N?'                   | in                     | Language ?   |                   |
| 'O' n                  | out                    | Active mode<br>n = 0 : Running mode (no security code has been entered at the keyboard)<br>n = 1 : Supervisor mode.<br>n = 2 : Engineer mode.<br>n = 3 : Viewing mode.<br>n = 4 : QA Inspector mode.<br>n = 5 : QA Operator 1 mode.<br>.<br>.<br>n = 13: QA operator 9 mode.   | <b>X</b>          |
| 'O?'                   | in                     | Which mode is active ?   |                   |

## APPENDIX D

| Command <sup>1 2</sup>  | Direction <sup>3</sup> | Description   | Type <sup>4</sup> |
|-------------------------|------------------------|---|-------------------|
| 'P' n                   | in/out                 | Product Number.<br>n = The value of the detectors product number. A two digit number, with leading zeroes, in the range [0...20].   | <b>P</b>          |
| 'P?'                    | in                     | Current product number ?  |                   |
| 'Q'                     | -----                  | <i>SEE LATER FOR DETAILS OF IDENTIFIER 'Q'</i>  | <b>X</b>          |
| 'q' m ',' n             | in/out                 | Automatic tracking enable<br>m = product number, a two digit number in the range [1..20]<br>n = 0 : NO<br>n = 1 : YES   | <b>P</b>          |
| 'q?' m                  | in                     | Automatic tracking enabled (for product number m) ?   |                   |
| 'R' n                   | out                    | Detection status<br>n = 0 : Normal<br>n = 1 : Detection   | <b>X</b>          |
| 'R?'                    | in                     | Detection Status ?  |                   |
| 'r' n                   | in/out                 | Pack sensor fitted<br>n = 0 : NO<br>n = 1 : YES   | <b>X</b>          |
| 'r?'                    | in                     | Pack sensor fitted ?  |                   |
| 'S' a ',' b ',' c ',' d | in/out                 | Security codes<br>Each of these is a four digit number in the range [0..9999].<br>a = Supervisor code<br>b = Engineer code<br>c = Viewing code<br>d = QA Inspector code   | <b>X</b>          |
| 'S?'                    | in                     | Security codes ?  |                   |
| 's' n                   | in/out                 | Pack sensor calibration<br>n = 0: Pack sensor calibration finished.<br>n = 1: Pack sensor calibration start<br><u>Note</u><br><i>The host sends 's1' to start calibrating. The detector will respond 's1' during calibration and 's0' when calibration is finished.</i> | <b>X</b>          |
| 's?'                    | in                     | Pack sensor calibration   |                   |

| Command <sup>1,2</sup>              | Direction <sup>3</sup> | Description   | Type <sup>4</sup> |
|-------------------------------------|------------------------|---|-------------------|
| 'T' t ; 'n' ; 'r' ; 'd' ; 'p' ; 'w' | in/out                 | <p>Timer Settings<sup>6</sup></p> <p>t = Timer group<br/> t = 0 : timer group A<br/> t = 1 : timer group B<br/> t = 2 : timer group C</p> <p>n = Timer type<br/> n = 0 : Timer type tm1<br/> n = 1 : Timer type tm2<br/> n = 2 : Timer type tm2G<br/> n = 3 : Timer type tm3<br/> n = 4 : Timer type tm3G</p> <p>r = Reject time, a five digit number in the range [50..60000].<br/> d = Signal delay, a five digit number in the range [50..60000].<br/> p = Sync delay, a five digit number in the range [50..60000].<br/> w = Window time, a five digit number in the range [50..60000].</p> <p><b>Note.</b> For timer types tm3 and tm3G the titles and range of acceptable values differ from those shown, refer to the instruction manual for details.<br/> <b>Note.</b> The resolution on all timer settings is 2ms.</p> | X                 |
| 'T?' t                              | in                     | Timer Settings ?  |                   |
| 'U' y ; 'm' ; 'd'                   | in/out                 | <p>Date</p> <p>y = The year, a two digit number in the range [0..99].<br/> m = The month, a two digit number in the range [1..12].<br/> d = The day of the month, a two digit number in the range [1..31]</p>   | X                 |
| 'U?'                                | in                     | Date ?  |                   |
| 'V' f ; 'n'                         | in/out                 | <p>Sensitivity limit</p> <p>f = Frequency offset, a single digit number in the range [0..1].<br/> <i>(Must be 0 for single frequency heads)</i><br/> n = Sensitivity limit, a three digit number in the range [0...199].</p>  | F                 |
| 'V?'f                               | in                     | Sensitivity limit   |                   |
| 'W' h ; 'm'                         | in/out                 | <p>Time, See Note 2.</p> <p>h = The hour, a two digit number in the range [0..23]<br/> m = The minute, a two digit number in the range [0..59]</p>  | X                 |
| 'W?'                                | in                     | Time ?  |                   |
| 'w' m ; 'n' ; 'o' ; 'p'             | in/out                 | <p>Automatic tracking setup</p> <p>m : Automatic tracking maximum rate, a five digit, fixed point, number in the range [1.00...5.00].<br/> n : Automatic tracking maximum span, a four digit, fixed point, number in the range [3.00...45.00].<br/> o : Automatic tracking damping, a single digit number in the range [1... 9].<br/> p : Reserved, always zero.</p>  | F                 |
| 'w?'                                | in                     | Automatic tracking setup?   |                   |
| 'X' m ; 'n'                         | in/out                 | <p>Product signal cancellation</p> <p>m = product number, a two digit number in the range [1..20]<br/> n = 0 : DISABLE<br/> n = 1 : ENABLE</p>  | P                 |
| 'X?' m                              | in                     | Product signal cancellation (for product number m)?   |                   |

# APPENDIX D

| Command <sup>1 2</sup> | Direction <sup>3</sup> | Description  | Type <sup>4</sup> |
|------------------------|------------------------|--|-------------------|
| 'Y' n ',' t            | in                     | Window timer calibration<br>n = 1 : Start the window time calibration<br>t = Timer group<br>t = 0 : timer group A<br>t = 1 : timer group B<br>t = 2 : timer group C  | <b>X</b>          |
| 'Y' n                  | out                    | Window time calibrating<br>n = 0 : NO<br>n = 1 : Calibration in progress   |                   |
| 'Y?'                   | in                     | Window time calibrating?   |                   |
| 'y' m, p               | out                    | Automatic tracking sensitivity & phase<br>m = Tracking sensitivity 3-digit number, in the range [0..199].<br>p = Tracking phase, five digit, fixed point number, in the range [0.00...180.00], resolution is 0.02. | <b>P</b>          |
| 'y?'                   | in                     | Automatic tracking sensitivity & phase?  |                   |
| 'Z' n                  | in/out                 | Detection Method<br>n = 0 : Amplitude only<br>n = 4 : Amplitude + Boost  | <b>X</b>          |
| 'Z?'                   | in                     | Detection Method ?   |                   |
| 'z01,' p ',' s         | in/out                 | Product name<br>p = product number, a two digit number in the range [0...20]<br>s = A string of alphanumeric characters. s must be 14 characters long  | <b>P</b>          |
| 'z01?' p               | in                     | Product name?  |                   |
| z02                    | -----                  | <i>SEE LATER FOR DETAILS OF IDENTIFIER 'z02'</i>   | <b>X</b>          |
| 'z03,' v               | in/out                 | Product speed<br>v = A fixed point number of the speed (m/min) in the range [0.5...200.0]<br><i>U.S. version only</i><br>v = A fixed point number of the speed (feet/min) in the range [1.6...656.1]               | <b>X</b>          |
| 'z03?'                 | in                     | Product speed?   |                   |
| 'z05,' d               | in/out                 | Sensor distance<br>d = Sensor distance in mm. A four digit number in the range [10...9999]<br><i>U.S. version only</i><br>d = Sensor distance in inches. A three digit number in the range [1...400]               | <b>X</b>          |
| 'z05?'                 | in                     | Sensor distance?   |                   |

|               |        |  |                    |
|---------------|--------|--|--------------------|
| 'z09' f ',' n | in/out | Reference phase<br>f = Frequency offset, one digit number in the range [0..1].<br>n = Reference Phase, a four digit, fixed point, number in the range [-45.00 ...+45.00] | <b>New command</b> |
| 'z09?'f       | in     | Reference (at frequency f) ?   |                    |
| 'z14', n      | In/out | Keyboard disable /enable<br>N = 0: Keyboard enabled<br>N = 1: Keyboard disabled  | <b>New command</b> |
| 'z14' ?       | In     | Keyboard enabled ?   |                    |
| 'z99?'        | Out    | SW version   | <b>New command</b> |

## NOTES

- 1 Those characters shown inside single quotes ' ', are to be sent as shown in the identifier column (ASCII representation of characters is used).
- 2 **xx?** is a request to the detector for information, (where **xx** is one of the identifiers in the identifier tables).
- 3 The direction that the identifier may be transmitted is with reference to the detector. (**out** = transmitted by detector, **in** = received by detector ).
- 4 The "Type" field in the above table is used to categorise the identifiers into their sphere of influence. Thus :-
  - F: Factory Setting
  - P: Product dependent setting.
  - X: Neither of the above.
- 5 Note on bargraph values  
A count of ten in the bargraph reading transmitted by the detector is equivalent to 1 bargraph led illuminated. Thus for all bargraph segments to be illuminated a minimum count of 200 would be necessary.
- 6 Note on timer types.  
Not all the timer types use all the parameters that are transmitted with the 'T' identifier. However, the host must always send the correct number of variables to the detector, and similarly, the detector always responds with the correct number of variables. To alleviate this restriction the detector will accept the value 0 for those values unused by the selected timer type when transmitted from the host. The detector in turn will send the current state of these values in its responses, independent of the timer mode.

For customers wishing to control our product via serial link only (without a local Man Machine Interface fitted to the detector), Safeline recommends to implement an additional set of commands, to ensure full access to factory settings. This need may arise, if the original factory setting needs to be adjusted or reset. If the above is required, contact your local supplier for the relevant information.

**Command Identifier - 'b'****Automatic setup Procedure**

*The Automatic setup procedure can be started remotely by the host or from the front panel keypad, in either case the front panel display and the communications commands would be in synchronisation. If the host starts the Automatic setup procedure remotely, with the commands given below, then the display will operate just as if the Automatic setup procedure had been started from the front panel keyboard.*

**Commands the host can transmit**

The host can send any of the following messages :-

- 'b1'<sup>1,2</sup> This starts the automatic setup procedure operating for the current product number.
- 'b?' This returns the current state of the automatic setup procedure (see the 'b'n command description below).
- 'b14' This command should be sent when the detector is in a state where a YES or NO decision is made. Transmitting this command is equivalent to selecting YES on the keypad.
- 'b90' This command should be sent when the detector is in a state where a YES or NO decision is made. Transmitting this command is equivalent to selecting NO on the keypad.
- 'b99' This command is sent when the host wishes to abort the automatic setup procedure and return to normal operation. This is equivalent to pressing the front panel key 'PROG/EXIT' during the automatic setup, and will cause the same action to occur in the metal detector.

For a description of the states see the 'Auto Setup Flowchart

**Commands the metal detector may transmit**

The following command will be transmitted in response to a 'b?' command above, or automatically during the operation of automatic setup.

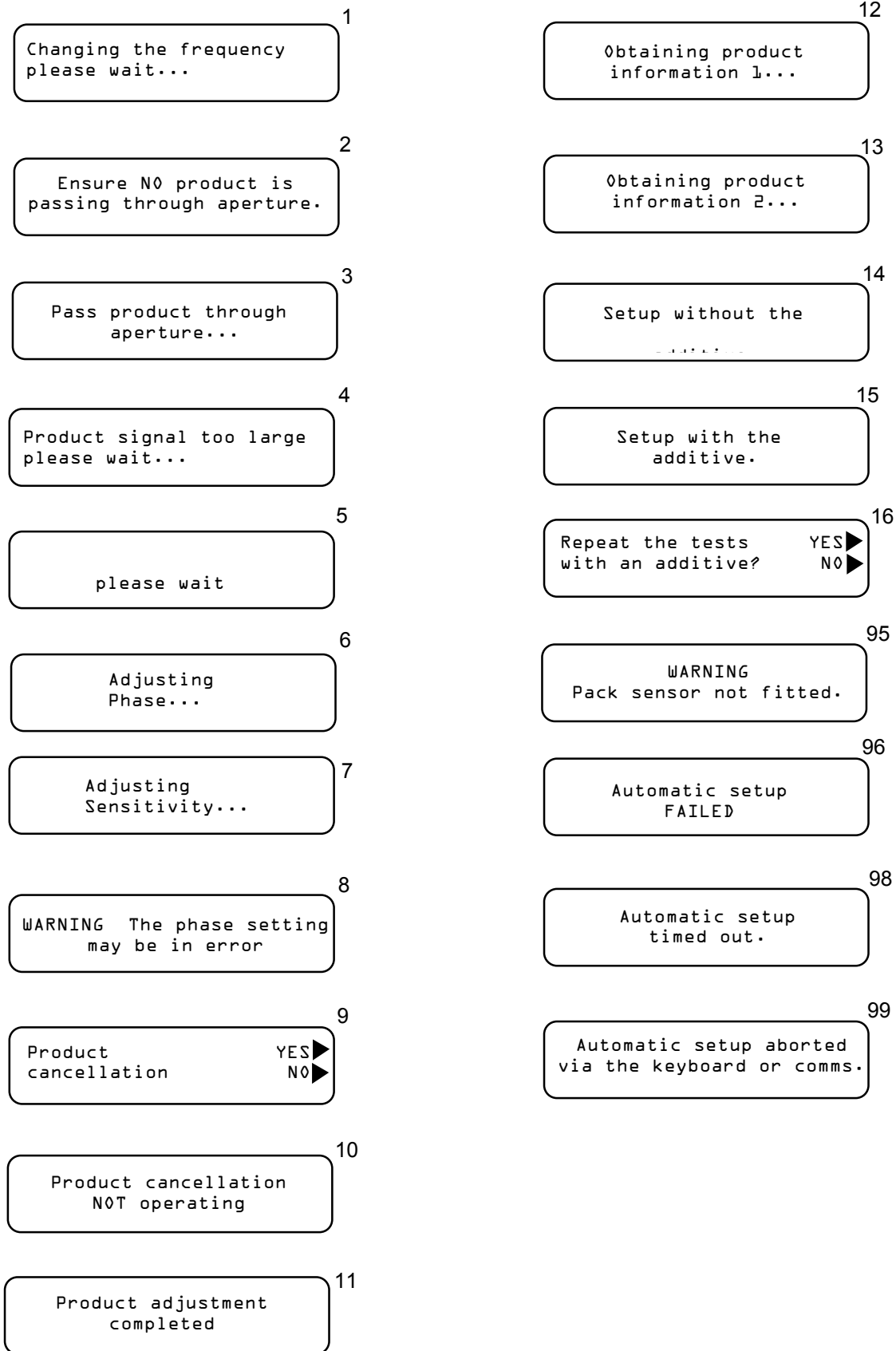
- 'b'n n is a number indicating the state of the automatic setup's progress, the number, n, corresponds with the displays normally on the front panel display as shown on the next page.

*Note the special case  $n = 0$  means that automatic setup is not running.*

**Notes**

- <sup>1</sup> During an Auto Setup procedure, initiated by the host, the transmission of the bargraph and detection messages ('A'n and 'R'n), will be suppressed. After completing the automatic setup, these messages will be resumed if they had been enabled prior to entering the automatic setup.
- <sup>2</sup> The command 'b1' cannot be sent if the current product number is 0. Automatic setup is not available on product number 0





## Command Identifier - 'E'

## Error Codes

In the case of an error in a received message being decoded at the detector, an error message would be returned to the host. This message would take the following form :-

'E' e ',' m

where e is the major error number. This can have one of the following values:-

**Table D-2 Major error codes**

| e (major error) | Type of error    | Description of error  |
|-----------------|------------------|---|
| 0               | No Error, OK     | Received command was OK.  |
| 1               | Protocol Error   | The detector tried to send too many commands, within a single message, and caused a buffer overflow, (see later). |
| 2               | Identifier Error | An unknown identifier was received. Please refer to the tables of acceptable identifiers.                         |
| 3               | Value-list Error | A comma was missing, wrong value type, letter instead of number in the received command, etc                      |
| 4               | Bounds Error     | A value was outside acceptable limits. Please refer to the previous tables for the range that values can take.    |
| 5               | Not used         | Reserved for future development   |

'm' is the minor error number, and takes on a different meaning dependent upon its preceding major error number.

**Table D-3 Minor error codes**

| m (minor error) | Description of error  |
|-----------------|---|
| 0               | No Error, this is sent only with the major-error number set to 0.   |
| 1               | Buffer Error, this is sent with the Protocol Error major number. This means that the transmit buffer inside the detector, (256 bytes long), was filled.   |
| Decimal number  | <p>This number is the decimal representation of an ASCII character.</p> <p>In the case of an Identifier Error this character was not recognised as an acceptable identifier.</p> <p>In the case of a Value-list Error this character or number caused the Value-list Error.</p> <p>In the case of the Bounds Error this character is the identifier whose value(s) were outside the acceptable range.</p> |

## Command Identifier - 'j' procedure

## Automatic sensitivity limit

The Automatic sensitivity limit procedure can be started remotely by the host or from the front panel keypad, in either case the front panel display and the communications commands would be in synchronization. When the host starts the Automatic sensitivity limit procedure remotely, with the command 'j1' given below, then the display will operate just as if the Automatic sensitivity limit procedure had been started from the front panel keyboard.

### Commands the host may transmit:

The host can send any of the following messages :-

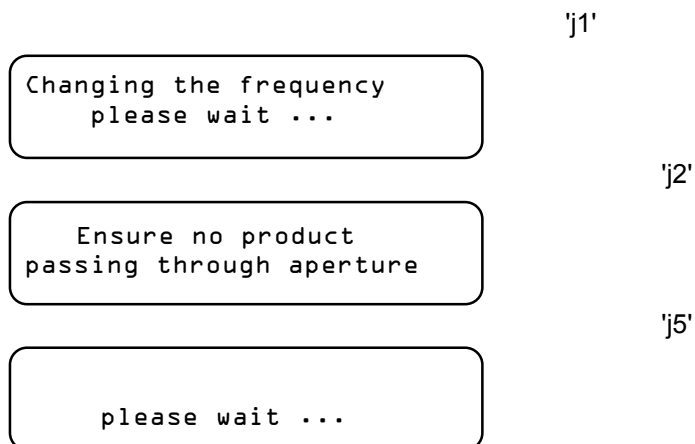
- 'j1'<sup>1,2,3</sup> This starts the automatic sensitivity limit procedure operating for the current product number.
- 'j?' This returns the current state of the automatic sensitivity limit procedure (see the 'j'n command description below).
- 'j99' This command is sent when the host wishes to abort the automatic sensitivity limit procedure and return to normal operation. This is equivalent to pressing the front panel Security key during the automatic sensitivity limit, and will cause the same action to occur in the metal detector.

### Commands the metal detector may transmit

The following command will be transmitted in response to a 'j?' command above, or automatically during the operation of automatic sensitivity limit.

- 'j' n n is a number indicating the state of the automatic sensitivity limit's progress, the number, n, corresponds with the displays on the front panel display as shown below.

*Note the special case  $n = 0$  means that automatic sensitivity limit is not running.*



### Notes

- <sup>1</sup> During an automatic sensitivity limit procedure, initiated by the host, the transmission of the bargraph and detection messages ('A'n and 'R'n), will be suppressed. After completing the automatic sensitivity limit, these messages will be resumed if they had been enabled prior to entering the automatic sensitivity limit.
- <sup>2</sup> The command 'j1' cannot be sent if the current product number is 0. Automatic sensitivity limit is not available on product number 0.
- <sup>3</sup> The command 'j1' cannot be sent if either Automatic Speed or Automatic setup is running.

**Command Identifier - 'Q'**

**QA Lists and Displays**

All QA relevant displays (see 'QA Operator Mode' and 'QA Inspector Mode' flowcharts in the manual) will be represented as a separate subseries from the main protocol letters. The elements of the subseries would be identified by a number corresponding to the numbered position in the flowcharts mentioned. Thus the subseries would be identified primarily by its letter 'Q' and then by its position within the 'Q' subseries by a number. In the following table both the leading letter and the subseries element number are shown:

**QA Operator commands**

| Command <sup>1,2</sup>    | Direction <sup>3</sup> | Description   | Type <sup>4</sup> |
|---------------------------|------------------------|---|-------------------|
| 'Q01,' m ',' n<br>' ',' o | in/out                 | Test Sample Material<br>m = product number<br>n = Sample<br>n = 0 : Ferrous<br>n = 1 : None - Ferrous<br>n = 2 : Stainless Steel<br>o = Test Result<br>o = 0 : Failed<br>o = 1 : Passed | <b>P</b>          |
| 'Q01?'                    | in                     | Request last values of m, n, and o used by the detector.  |                   |
| 'Q02' ....<br>'Q09'       | -----                  | Reserved for later use  | <b>X</b>          |

**QA Inspector commands**

| Command <sup>1,2</sup>    | Direction <sup>3</sup> | Description  | Type <sup>4</sup> |
|---------------------------|------------------------|--|-------------------|
| 'Q10,' n                  | in/out                 | Printing<br>n = 0 : Print(ing) all settings<br>n = 1 : Print(ing) shift reports  | <b>X</b>          |
| 'Q11,' n                  | in/out                 | Line identification number<br>n = 4 digits number  | <b>X</b>          |
| 'Q11?'                    | in                     | Line Identification Number ?   |                   |
| 'Q12,' n                  | in/out                 | Printer Selected<br>n = 0 : NO<br>n = 1 : YES  | <b>X</b>          |
| 'Q12?'                    | in                     | Printer selected ?   |                   |
| 'Q13,' m ',' n<br>' ',' o | in/out                 | Sample Size Registration<br>m = Product number, a two digit number in the range [0..20].<br>n = 0 : Ferrous Sample<br>n = 1 : None - Ferrous Sample<br>n = 2 : Stainless Steel Sample<br>o = Sample size in mm, a two digit number in the form X.X<br>(E.g. 09 = 0.9 mm) | <b>P</b>          |
| 'Q13?' m ',' n            | in                     | Sample Size Registration ?   |                   |
| 'Q14,' n                  | in/out                 | Shift Report options<br>n = 0 : Reject Relay Operations OUT      Modified Settings<br>OUT<br>n = 1 : Reject Relay Operations OUT      Modified Settings IN<br>n = 2 : Reject Relay Operations IN      Modified Settings<br>OUT   | <b>X</b>          |
| 'Q14?'                    | in                     | n = 3 : Reject Relay Operations IN      Modified Settings IN<br>Shift Report options ?   |                   |

| Command <sup>1,2</sup> | Direction <sup>3</sup> | Description   | Type <sup>4</sup> |
|------------------------|------------------------|---|-------------------|
| 'Q15,' h ',' m         | in/out                 | Shift Report Interval Time<br>h = Two digit number, of the hour, in the range [0..24].<br>m = Two digit number, of the minute, in the range [0..59].<br>Maximum shift report interval time is 24:00                             | X                 |
| 'Q15?'                 | in                     | Shift Report Interval ?   |                   |
| 'Q16,' h ',' m         | in/out                 | Shift Report Start Time<br>h = Two digit number, of the hour, in the range [0..23].<br>m = Two digit number, of the minute, in the range [0..59].<br>Maximum shift report start time is 23:59                                   | X                 |
| 'Q16?'                 | in                     | Shift Report Start Time ?   |                   |
| 'Q17,' h ',' m         | in/out                 | Test Interval<br>h = Single digit number, of the hour, in the range [0..8].<br>m = Two digit number, of the minute, in the range [0..59].<br>Maximum test interval time is 08:59  | X                 |
| 'Q17?'                 | in                     | Test Interval ?   |                   |
| 'Q18,' h ',' m         | in/out                 | Overdue Period<br>h = Single digit number, of the hour, in the range [0..4]<br>m = Two digit number, of the minute, in the range [0..59]<br>Maximum overdue period must be less than half of 'Test Interval and less than 04:59 | X                 |
| 'Q18?'                 | in                     | Overdue Period ?  |                   |
| 'Q19,' n               | in/out                 | Alarm if Due/Overdue Setting<br>n = 0 : DUE<br>n = 1 : OVERDUE  | X                 |
| 'Q19?'                 | in                     | Alarm if Due/Overdue Status ?   |                   |
| 'Q20,' n ',' o         | in/out                 | QA Operator Number and Code<br>n = Operator number, a single digit number in the range [1..9].<br>o = 4 digit code for the operator n, in the range [0..9999].  | X                 |
| 'Q20?' n               | in                     | QA Operators code ?   |                   |
| 'Q21,' n               | in/out                 | Printer type<br>n = 0 : FIXED<br>n = 1 : PORTABLE   | X                 |
| 'Q21?'                 | in                     | Printer type ?  |                   |

**NOTES**

- <sup>1</sup> Those characters shown inside single quotes ' ', are to be sent as shown in the identifier column. (ASCII representation of characters is used).
- <sup>2</sup> **xx?** is a request to the detector for information, (where **xx** is one of the identifiers in the identifier tables).
- <sup>3</sup> The direction that the identifier may be transmitted is with reference to the detector. ( **out** = transmitted by detector, **in** = received by detector ).
- <sup>4</sup> The "Type" field in the above table is used to categorise the identifiers into their sphere of influence.  
Thus :-  
F: Factory Setting.  
X: Neither of the above.  
P: Product-dependent setting.

**Command Identifier - 'z02'**

**Automatic product speed procedure**

The Automatic product-speed procedure can be started remotely by the host or from the front panel keypad, in either case the front panel display and the communications commands will be in synchronization. When the host starts the Automatic product-speed procedure remotely, with the command 'z02,1' given below, then the display will operate just as if the Automatic product-speed procedure had been started from the front panel keyboard.

**Commands the host may transmit:**

The host can send any of the following messages :-

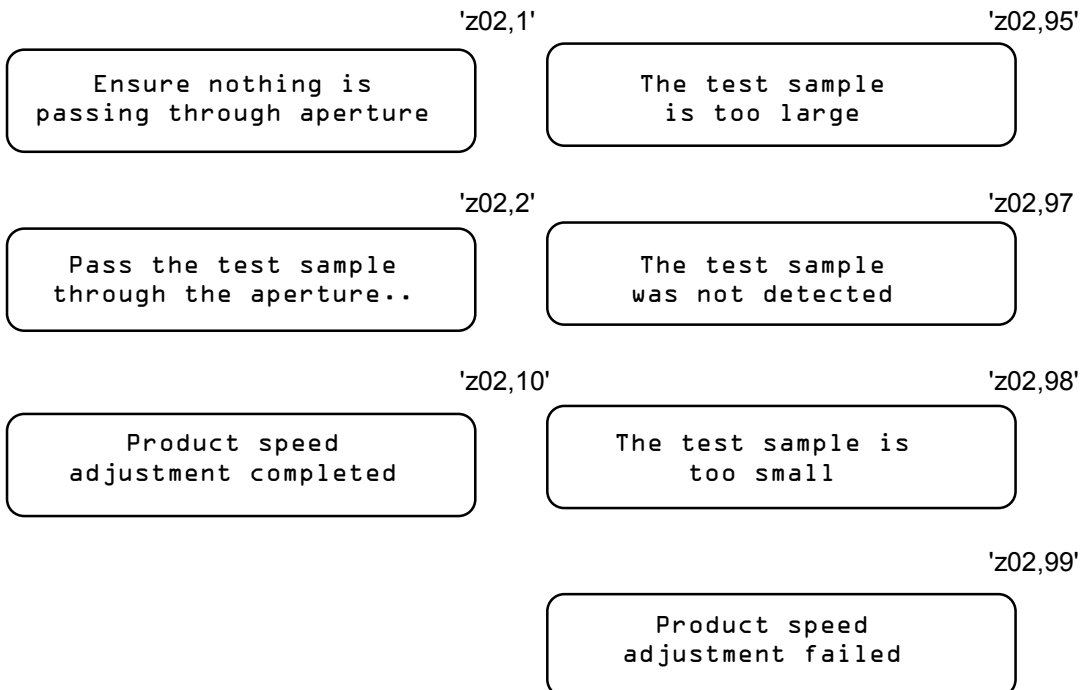
- 'z02, 1'<sup>1,2</sup> This starts the automatic product-speed procedure operating for the current product number.
- 'z02?' This returns the current state of the automatic product-speed procedure (see the 'z02'n command description below).
- 'z02,99' This command is sent when the host wishes to abort the automatic product-speed procedure and return to normal operation. This is equivalent to pressing the front panel security key during the automatic product-speed, and will cause the same action to occur in the metal detector.

**Commands the metal detector may transmit**

The following command will be transmitted in response to a 'z02?' command above, or automatically during the operation of automatic product-speed.

- 'z02,' n n is a number indicating the state of the automatic product-speed's progress, the number, corresponds with the displays on the front panel display as shown below.

*Note the special case n = 0 means that automatic product-speed is not running.*



Notes

- 1 During an automatic product-speed procedure, initiated by the host, the transmission of the bargraph and detection messages ('A'n and 'R'n), will be suppressed. After completing the automatic product-speed, these messages will be resumed if they had been enabled prior to commencing the automatic productspeed.
- 2 The command 'z02, 1' cannot be sent if either Automatic Setup or Automatic sensitivity limit is running.

## EMULATION MODE

### Objective

To generate a facility, which allows the remote control of the metal detector via the existing serial link. The remote MMI will be a 'look a like' of the local key panel, using the same display area as the LCD display (2 x 24 chars) and a copy of all the keys present on the local key panel.

### Principal of operation

Presently, the metal detector software uses the keys of the key panel as input device and the LCD screen as the output device.

The remote hardware (e.g. PC) will duplicate the I/O devices in a suitable way and as such provide the same facility to the operator as the local key panel.

Communication between the metal detector and the remote hardware is facilitated via the existing serial link.

### Serial command-set supporting emulation mode.

| Command <sup>1,2</sup>               | Direct <sup>3</sup> | Description  | Notes                                   |
|--------------------------------------|---------------------|--|---|
| 'z15', n                             | In/Out              | Emulation mode enabled /disabled<br>n=0 emulation disabled<br>n=1 normal emulation enabled.<br>n=2 fast emulation enabled<br><br>(See 'Emulation Mode' description for more details)                         | <b>Normal &amp; fast emulation mode</b> |
| 'z15?'                               | In                  | Emulation mode?  |   |
| 'z16',min,max                        | In/Out              | Fast emulation mode timing.<br>min = min gap time between messages (ms), default 20ms.<br>max = max gap time between messages (ms), default 1000ms.  | <b>Fast emulation mode only</b>         |
| 'z16?'                               | In                  | (See 'Emulation Mode' description for more details)<br><br>Emulation mode timing?  |   |
| 'z20',msg<br>(normal emulation mode) | Out                 | Remote display update<br><br>(See 'Emulation Mode' description for more details)   | <b>Normal emulation mode</b>            |
| 'z20?'                               | In                  | Request a copy of the current display.   |   |
| 'z20',msg<br>(Fast emulation mode)   | Out                 | Remote display update<br><br>Note: In fast emulation mode is automatically transmitted on a timed interval. It need not be requested by the host.<br><br>(See 'Emulation Mode' description for more details) | <b>Fast emulation mode</b>              |



| Command <sup>1,2</sup> | Direct <sub>3</sub> | Description   | Notes                                   |
|------------------------|---------------------|---|---|
| 'z22' n                | In                  | Key pressed command<br>n = U: Up key<br>n = D: Down Key<br>n = L: Left key<br>n = E: Enter key<br>n = X: Recall key<br>n = M: Menu key<br>n = S1: Soft key #1<br>n = S2: Soft key #2<br>n = S3: Soft key #3<br>n = S4: Soft key #4<br><br>(See 'Emulation Mode' description for more details) | <b>Normal &amp; fast emulation mode</b> |

### **Description of the emulation commands**

- **'z15' command: (enabled / disabled)**

There are three modes of operations:

#### 1. Emulation mode disabled

This represents the mode when no remote panel is used. The PCI protocol is unaffected. (Default mode after hardware reset).

#### 2. Normal Emulation mode

This mode of operation is achieved by using the emulation commands utilizing the existing protocol format. (i.e. no alterations to the existing protocol format are required).

The additional commands to implement this mode are: 'z15', 'z20', 'z22'

Note: In this mode the 'z20' command works under the normal protocol format using ACK's and NAK's.

#### 3. Fast emulation mode.

This mode makes use of the following commands: 'z15', 'z16', 'z20', 'z22'

In order to achieve a faster update rate, the 'z20' cmd works outside the normal protocol.

(All other commands use the normal protocol format).

- **'z16' command (timing for fast emulation mode)**

This command has two parameters (min. and max) and is only used for fast emulation mode.

min = min gap time between messages (ms), default 20ms.

This time is used by the metal detector, if a change to the screen message was detected.

max = max gap time between messages (ms), default 1000ms.

This time is used if there was no change to the screen message.

The timings should only be changed whilst fast emulation mode is not active. All times are approximate, typically the actual delay will be value + 8 ms.

Note: In most instances there should be no need to alter the default values.

- **'z20' command**

- The 'z20' cmd transmits the information to update the screen. This command behaves slightly different depending on the emulation mode used (fast or normal).
- In both modes (fast and normal emulation) the screen info data transmitted is packed as described under 'Screen package format'.

- **The 'z20' command in normal emulation mode**

- The command behaves like any other command under the PCI protocol.
- The screen update has to be requested by the host.
- The message format would look as follows:  
(STX)G(VALUE)M(VALUE)z20,(ENCODED DATAPACK)(ETX)(CRC)

- **The 'z20' command in fast emulation mode**

- The 'z20' cmd is automatically transmitted on a timed interval.(For timing see 'z16' cmd)
- The host processor must not respond with ACK/NAK's for the 'z20' cmd.
- The 'z20' message is 'injected' into the normal protocol data regardless if the serial link is busy or not.
- The start and end chars are different:  
(First char: 'SOH' 0x01 / End char: 'EOT' 0x04)  
This has been done to give the host the ability to filter out the screen update information from the normal protocol. The host has to scrutinize every character received for a potential 'SOH' character and, if detected, remove the screen up-date info from the normal protocol stream.
- The message format would look as follows:  
(SOH)z20,(ENCODED DATAPACK)(EOT)(CRC)

**Screen package format:**

The z20 command encodes a complete display update into a single, fixed length packet. The data [is base64 encoded](#) and needs decoding before use. As sent over the wire the packet format is:

z20,payload where payload = 72 bytes of base64 data.

After decoding the payload format is:

| Offset | Size (bytes) | Content                          |
|--------|--------------|----------------------------------|
| 0      | 24           | First line of LCD display        |
| 24     | 24           | Second line of LCD display       |
| 48     | 1            | Cursor type & position           |
| 49     | 5            | Soft character cache (5 entries) |

The LCD display data is binary, with 0..7 representing soft characters, the remainder being mainly standard ASCII display codes (up to 127). There are some differences between the LCD character set and that of a standard Windows machine. In particular:

| LCD Code | Character | Windows character code               |
|----------|-----------|--------------------------------------|
| 0        |           | not used                             |
| 1        | >         | or 0x25BA                            |
| 2        | <         | or 0x25C4                            |
| 3..7     |           | Soft character cache (0..5)          |
| 0xDF     | °         | 0x00B0                               |
| 0xE1     | ä         | 0x00E4                               |
| 0xEE     | ñ         | 0x00F1                               |
| 128..255 |           | Japanese / other special characters. |

The cursor is encoded as follows:

| Bit  | Content  |
|------|--|
| 7    | Underline cursor   |
| 6    | Block/blinking cursor  |
| 5..0 | Cursor position, 0..23 is the first row, 24..47 is the second row. |

If neither bits 6 or 7 are set then no cursor should be shown.

The soft character cache consists of a series of 5 bytes, each of which represents an index into the soft character map table. If a particular cache location is not in use then it will be set to 0xFF. The cache index is such that LCD char 3 maps to cache index 0 (i.e. subtract 3 from the LCD code to obtain the index into the cache). The cache is sent with each display update as the soft characters mapped into cache can change on each display update.

The soft character map is shown below.

| <u>Index</u> | <u>Unicode</u> |   | <u>Char</u>  | <u>Safeline Description</u> |
|--------------|----------------|---|--------------|-----------------------------|
| 0            | 0x00C6         | Æ | SOFT_AE      |                             |
| 1            | 0x00C0         | À | SOFT_AGRAVE  |                             |
| 2            | 0x00C4         | Ä | SOFT_AUMLAUT |                             |
| 3            | 0x00E6         | æ | SOFT_ae      |                             |
| 4            | 0x00E0         | à | SOFT_aGRAVE  |                             |
| 5            | 0x00E1         | á | SOFT_aACUTE  |                             |
| 6            | 0x00E4         | ä | SOFT_aUMLAUT |                             |
| 7            | 0x00E8         | è | SOFT_eGRAVE  |                             |
| 8            | 0x00D1         | Ñ | SOFT_NTILDE  |                             |
| 9            | 0x00D8         | Ø | SOFT_OSLASH  |                             |
| 10           | 0x00D6         | Ö | SOFT_OUMLAUT |                             |
| 11           | 0x00F3         | ó | SOFT_oACUTE  |                             |
| 12           | 0x00F8         | ø | SOFT_oSLASH  |                             |
| 13           | 0x00F6         | ö | SOFT_oUMLAUT |                             |
| 14           | 0x00F1         | ñ | SOFT_nTILDE  |                             |
| 15           | 0x00C5         | Å | SOFT_ACIRCLE |                             |
| 16           | 0x00E5         | å | SOFT_aCIRCLE |                             |
| 17           | 0x0141         | Ł | SOFT_LSLASH  |                             |
| 18           | 0x0142         | ł | SOFT_lSLASH  |                             |
| 19           | 0x015A         | Ś | SOFT_SSLASH  |                             |
| 20           | 0x015B         | ś | SOFT_sSLASH  |                             |
| 21           | 0x0106         | Ć | SOFT_CSLASH  |                             |
| 22           | 0x0107         | ć | SOFT_cSLASH  |                             |
| 23           | 0x017B         | Ż | SOFT_ZCIRCLE |                             |
| 24           | 0x017C         | ż | SOFT_zCIRCLE |                             |
| 25           | 0x0143         | Ń | SOFT_NSLASH  |                             |
| 26           | 0x0144         | ń | SOFT_nSLASH  |                             |
| 27           | 0x0118         | Ę | SOFT_ECOMMA  |                             |
| 28           | 0x0119         | ę | SOFT_eCOMMA  |                             |
| 29           | 0x014C         | Ō | SOFT_ODASH   |                             |
| 30           | 0x014D         | ō | SOFT_oDASH   |                             |
| 31           | 0x0104         | Ą | SOFT_ACOMMA  |                             |
| 32           | 0x0105         | ą | SOFT_aCOMMA  |                             |
| 33           | 0x0179         | Ź | SOFT_ZSLASH  |                             |
| 34           | 0x017A         | ź | SOFT_zSLASH  |                             |

- **'z22' command**

The single parameter transmitted with this command represents the pressed key.

n = U: Up key

n = D: Down Key

n = L: Left key

n = E: Enter key

n = X: Recall key

n = M: Menu key

n = S1: Soft key #1

n = S2: Soft key #2

n = S3: Soft key #3

n = S4: Soft key #4

The following should be kept in mind:

- There is no keyboard buffer. Until the module has processed the previous key press any further keys will overwrite the unprocessed one. This command is always available (regardless of z15 setting).

-In order to clear a fault via the local panel, the soft key 2 is pressed and held down for a certain time period. To simulate this action, it is necessary to send multiple SKEY2 emulated keys (z22,S2).

### **Simultaneous use of local and remote panel**

The local and remote key panel can be used simultaneously. If it is not desirable that the operator has the ability to alter the metal detector setting via the local key panel, the key board enable / disable command can be made use of ('z14' cmd).

## CRC GENERATION

A sixteen bit cyclic redundancy code ( CRC ) is used in preference to the more common checksum technique to minimize the possibility of the detector responding to a corrupted transmission.

### Method

A sixteen bit CRC accumulator is used, the data being transmitted over the link is four bytes of ASCII encoded hexadecimal with no leading zero suppression.

Polynomial used,

$$G(x) = x^{16} + x^{12} + x^5 + 1 \text{ (i.e CCITT)}$$

Data is processed Least Significant Disc (LSB) of character first and transmitted high byte and high nibble to low byte and low nibble.

The CRC accumulator is initialized to FFFF before every packet is started.

Example CRC Numbers.

| <u>MESSAGE STRING</u>          | <u>CRC (HEX)</u> |
|--------------------------------|------------------|
| T                              | 1B26             |
| THE                            | 44BE             |
| THE,QUICK,BROWN,FOX,0123456789 | DF91             |

Note: The CRC does not include the terminating null character in the above strings.

**Refer to the following C Program for a straightforward non-optimized CRC-CCITT routine.**

**C Program**

```

/*
  Straightforward, non-optimized CRC-CCITT routine.
  Assumes 16-bit integer variables.
  MSB of integer is MSB of CRC result.
*/

#define POLY          0x8408          /* Polynomial */

void main(void)
{
    unsigned int crc;

    crc = 0xffff;
    printf("crc of 'T' is 0x%x\n", bytecrc("T",&crc) );

    crc = 0xffff;
    printf("crc of 'THE' is 0x%x\n", blkcrc("THE",&crc,3) );

    crc = 0xffff;
    printf("crc of 'THE,QUICK,BROWN,FOX,0123456789' is
    0x%x\n",blkcrc("THE,QUICK,BROWN,FOX,0123456789",&crc,30));
} /* end main */

unsigned int blkcrc(unsigned char *bufptr, unsigned int *crcres, unsigned int count)
{
    int i;
    for (i = 1; i <= count; i++ , bufptr ++ )          /* do for whole block */
        bytecrc(bufptr, crcres);                       /* do CRC for 1 byte */

    return *crcres;
} /* end blkcrc */

unsigned int bytecrc(unsigned char *bufptr, unsigned int *crcres)
{
    unsigned int j, ch, Q;

    ch = (unsigned int) *bufptr;                       /* get char to int format */
    for (j = 1; j <= 8; j ++ )
    {
        Q = (*crcres & 0x0001) ^ (ch & 0x0001);
        /*
           Q = 1 if either crcres or data least significant bits are 1, but not both.
        */
        if ( Q == 0x0001 )
        {
            /*- Q is one */
            *crcres = *crcres >> 1;                 /* shift right one */
            *crcres = *crcres ^ POLY;                /* XOR with POLYnomial */
        }
        else
            /*- Q is zero */
            *crcres = *crcres >> 1;                 /* just shift no XOR */
        ch = ch >> 1;                               /* move next data into position */
    }
    return *crcres;
} /* end bytecrc */

```

## TIMING DIAGRAMS FOR SERIAL COMMUNICATIONS

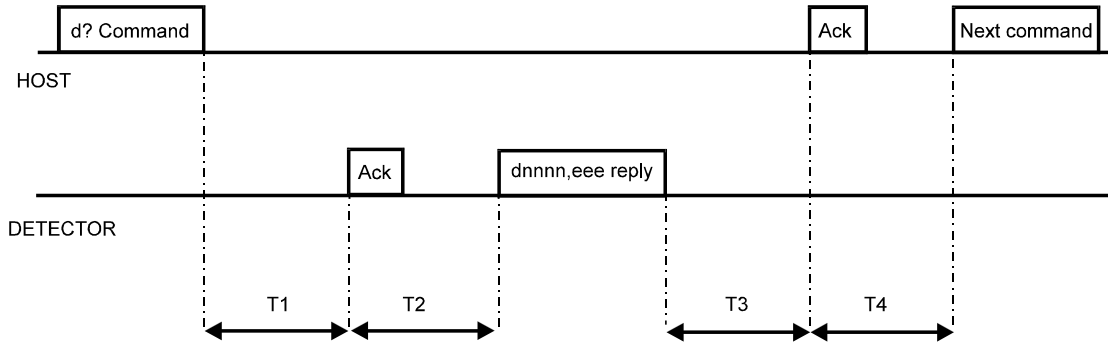


Fig 27 D-1 Host Query of Detector

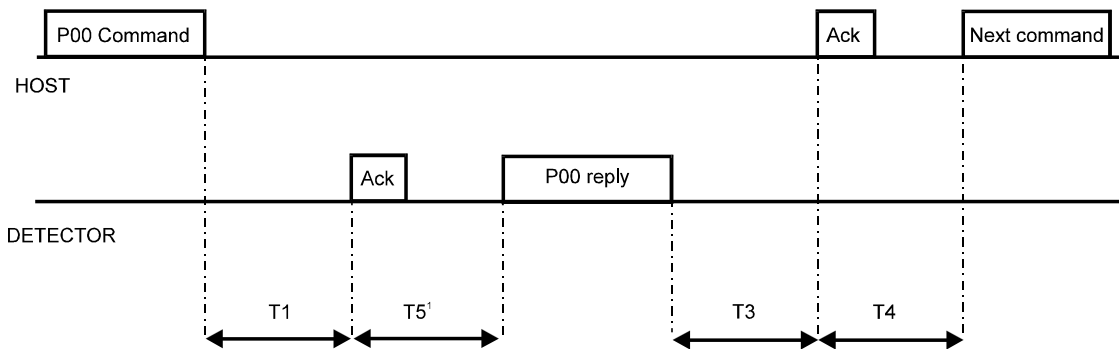


Fig 28 D-2 Host Command type 1, (causes change in value of detector variable)

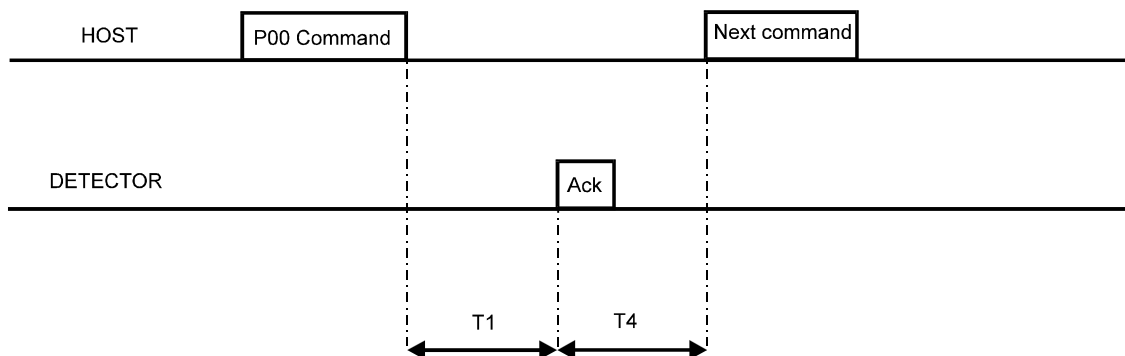


Fig 29 D-3 Host Command type 2, (causes NO change in value of detector variable)



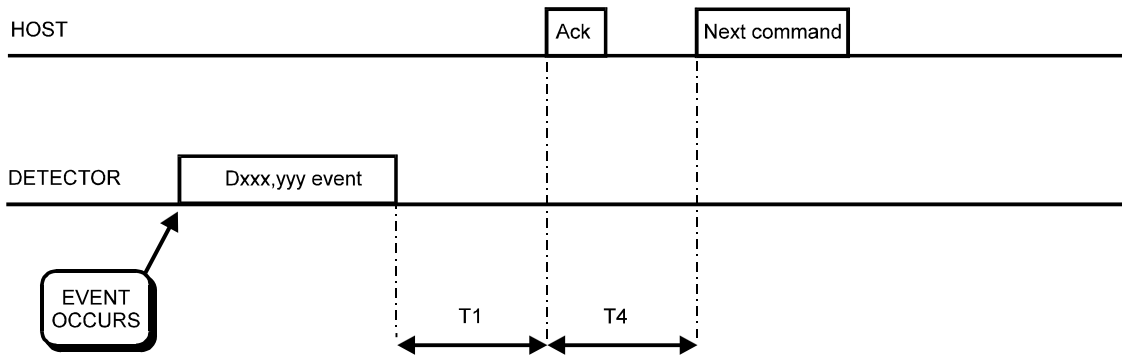
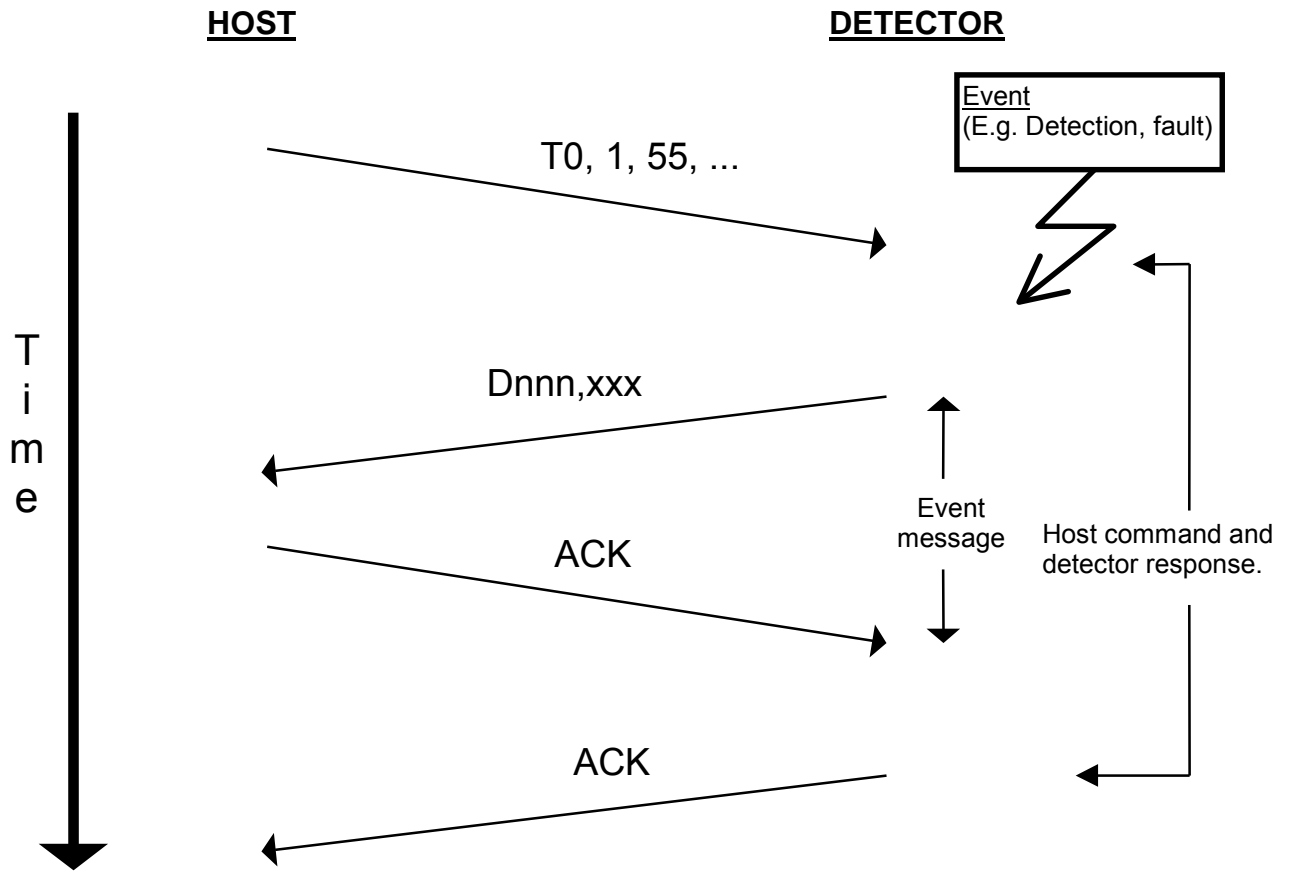


Fig 30 D-4 Event Occurrence inside detector

Table D-4 Absolute maximum timings

| Time | Minimum (ms) | Maximum (ms) |
|------|--------------|--------------|
| T1   | 0            | 250          |
| T2   | 0            | 250          |
| T3   | 0            | 250          |
| T4   | 200          | ∞            |
| T5   | 0            | 250          |

Fig 31 Event driven message interrupting normal ack/nak response to the host



## MAGNETIC LOOPS

The design and Construction of the metal detector support framework can influence the performance of the detector.

A metal detector with excellent vibration characteristics, if mounted on a structure containing magnetic loops can be made to look extremely poor and very sensitive to vibration.

Metalwork, even though positioned outside the normal metal free zone can still act as an aerial or receiver for the magnetic field from the detector, making the whole framework susceptible, to loop effects.

The leakage magnetic field from the aperture of the detector can generate minute electrical currents that flow in the surrounding metalwork. They in turn influence the detector. An electric current will flow if a closed electrical path or loop exists.

A typical installation could be a metal detector mounted on a metallic conveyor frame with rollers positioned across the frame as shown in Figure 5 in the Installation Section.

The magnetic field from the detector can radiate into the conveyor frame, this in turn would create minute electrical currents which would flow through the closed path or loop created by the rollers mounted across the conveyor frame.

Problems with loops can be avoided by opening or closing the loop in a permanent manner. It is the intermittent nature of a loop path that causes intermittent triggering of the metal detector.

The problem with the rollers on the conveyor can be overcome by insulating one end of the roller from the conveyor frame. This may take the form of plastic insulation plate and washers on the bearing mounting block or supply a plastic extension to end of the roller shaft (see Fig 6 in the Installation Section). By insulating the roller in this way the loop is opened permanently.

The conveyor frame itself should be of welded construction rather than bolted sections. A welded construction is an example of a permanently closed loop.

Any items bolted to the conveyor frame, particularly items positioned across the conveyor (eg guards) potentially create loops. To avoid difficulties insulate/isolate all items bolted to the frame.

Record all your settings here, (use the Viewing Mode and Engineer Mode).

Note in the table below items marked with an asterix, \*, are optional items that may not be fitted in your detector.

Detector Details

|                  |  |
|------------------|--|
| Serial Number    |  |
| Model            |  |
| Software Version |  |

Notes

Product Details

| Nr | Product name | Sens. | Phase  | Operating frequency | Power Drive | Timer group | Inverse detect | Automatic tracking* | P.S.C.* |
|----|--------------|-------|--------|---------------------|-------------|-------------|----------------|---------------------|---------|
| 0  |              |       | 000.00 |                     |             |             |                | no                  | no      |
| 1  |              |       |        |                     |             |             |                |                     |         |
| 2  |              |       |        |                     |             |             |                |                     |         |
| 3  |              |       |        |                     |             |             |                |                     |         |
| 4  |              |       |        |                     |             |             |                |                     |         |
| 5  |              |       |        |                     |             |             |                |                     |         |
| 6  |              |       |        |                     |             |             |                |                     |         |
| 7  |              |       |        |                     |             |             |                |                     |         |
| 8  |              |       |        |                     |             |             |                |                     |         |
| 9  |              |       |        |                     |             |             |                |                     |         |
| 10 |              |       |        |                     |             |             |                |                     |         |
| 11 |              |       |        |                     |             |             |                |                     |         |
| 12 |              |       |        |                     |             |             |                |                     |         |
| 13 |              |       |        |                     |             |             |                |                     |         |
| 14 |              |       |        |                     |             |             |                |                     |         |
| 15 |              |       |        |                     |             |             |                |                     |         |
| 16 |              |       |        |                     |             |             |                |                     |         |
| 17 |              |       |        |                     |             |             |                |                     |         |
| 18 |              |       |        |                     |             |             |                |                     |         |
| 19 |              |       |        |                     |             |             |                |                     |         |
| 20 |              |       |        |                     |             |             |                |                     |         |

Engineer Mode Settings

|                      |  |
|----------------------|--|
| Detection buzzer     |  |
| Pack sensor fitted   |  |
| Operator access      |  |
| Speed range          |  |
| Detector speed       |  |
| Reject inhibit       |  |
| Reject confirmation* |  |
| Reject confirm time* |  |
| Boost mode           |  |
| Language             |  |
| Printer handshake*   |  |
| Maximum rate         |  |
| Maximum span         |  |
| Damping              |  |

# SETTINGS SHEET

## Timer Groups Setup

| Group | Type |  |  |  |  |
|-------|------|--|--|--|--|
| A     |      |  |  |  |  |
| B     |      |  |  |  |  |
| C     |      |  |  |  |  |

## Sensitivity limit

| Frequency | Sensitivity limit |
|-----------|-------------------|
|           |                   |
|           |                   |

## Sample Sizes

| Nr | Ferrous | Non Ferrous | Stainless Steel |
|----|---------|-------------|-----------------|
| 0  |         |             |                 |
| 1  |         |             |                 |
| 2  |         |             |                 |
| 3  |         |             |                 |
| 4  |         |             |                 |
| 5  |         |             |                 |
| 6  |         |             |                 |
| 7  |         |             |                 |
| 8  |         |             |                 |
| 9  |         |             |                 |
| 10 |         |             |                 |
| 11 |         |             |                 |
| 12 |         |             |                 |
| 13 |         |             |                 |
| 14 |         |             |                 |
| 15 |         |             |                 |
| 16 |         |             |                 |
| 17 |         |             |                 |
| 18 |         |             |                 |
| 19 |         |             |                 |
| 20 |         |             |                 |

## Q.A. Setup

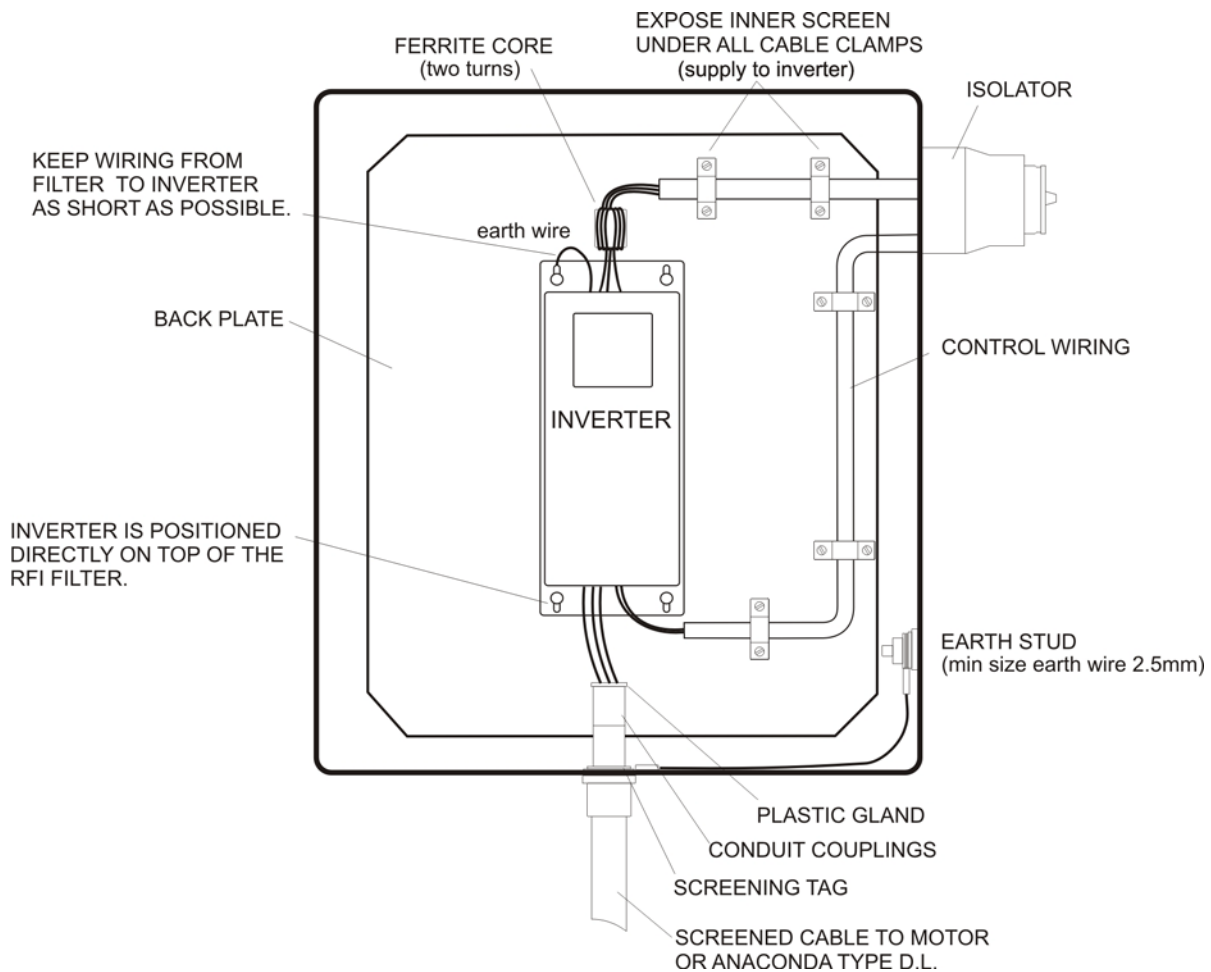
|                          |  |
|--------------------------|--|
| Line id*                 |  |
| Printer*                 |  |
| Printer*                 |  |
| Reject relay operations* |  |
| Modified settings*       |  |
| Shift report interval*   |  |
| Shift report start*      |  |
| Test interval*           |  |
| Overdue period*          |  |
| Alarm if due/overdue*    |  |

## Distributor use only

|                             |  |
|-----------------------------|--|
| Com1                        |  |
| A.S. reject inhibit         |  |
| Reject confirmation option  |  |
| Performance check option    |  |
| Product cancellation option |  |
| Switched frequency          |  |
| Fe Phase                    |  |

|                           |  |
|---------------------------|--|
| Automatic tracking option |  |
| Auxiliary output          |  |

# RECOMMENDATIONS FOR THE USE OF INVERTERS



This is a typical layout of the inverter supplied by safeline.

**Do attempt to install, operate, maintain or inspect the inverter until you have read through the instruction manual supplied with the inverter.**

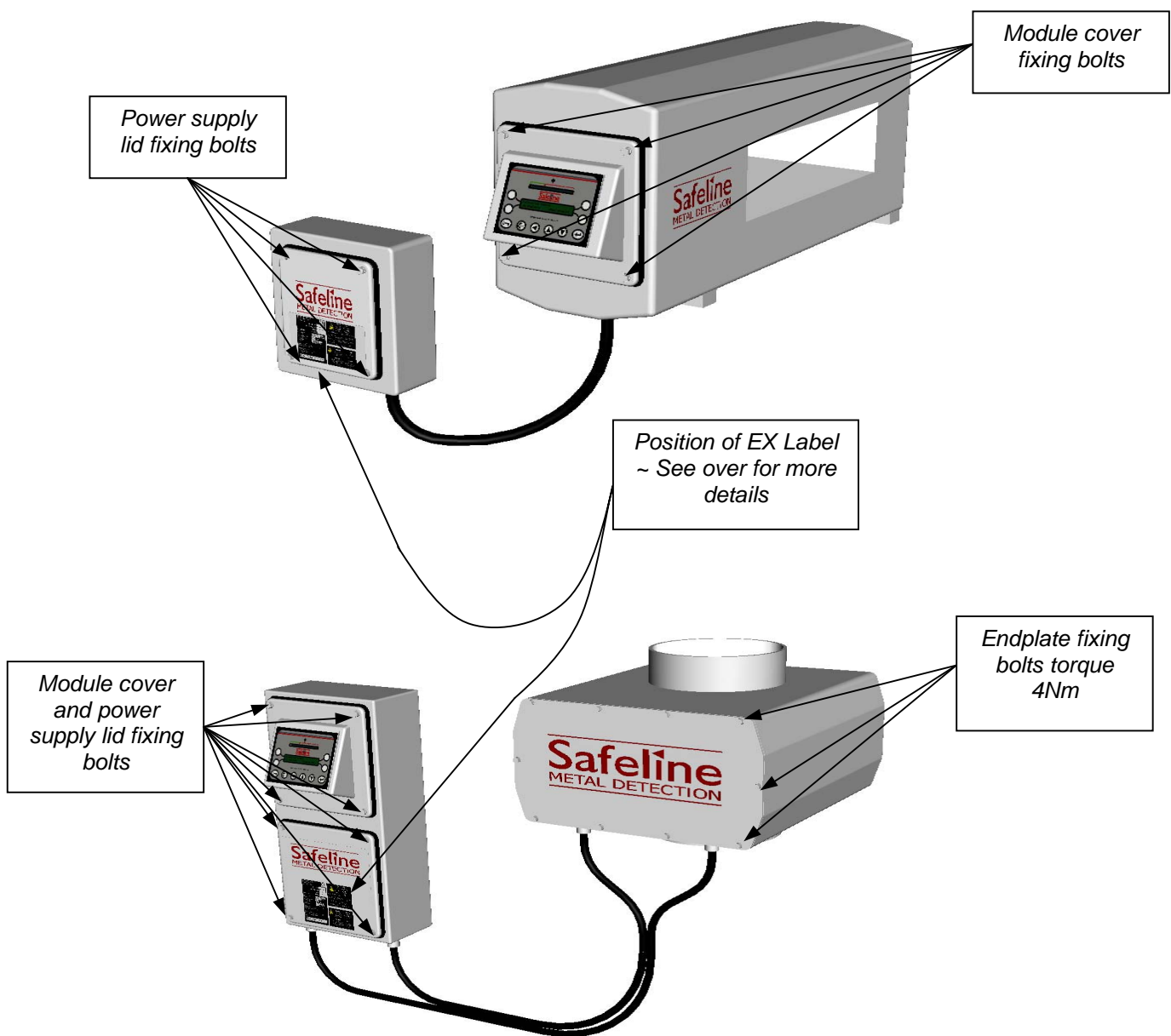
Safeline use Mitsubishi as our supplier of inverters, we know this works well with the metal detector and we have carried out extensive tests to meet the requirements of the CE regulations.

## General counter measures.

1. Keep wiring inside control box as far away from inverter as possible.
2. Motor cables should be run separate from any other cables and as far from the metal detector as possible.
3. External screened cables should be grounded at suitable intervals where possible.
4. Remove insulation only where screening clamps are shown to provide good earth continuity at that point.
5. Do not run the power cables(I/O cables) and signal cables of the inverter in parallel with each other and do not bundle them.
6. Use twisted shield cables for the detector connecting and the control signals.
7. Ground inverter, motor, etc. at one point.
8. Capacitances exist between the inverter's I/O wiring, other cables, earth and motor, through which leakage currents flow to cause the earth leakage circuit breaker, earth leakage relay to operate unnecessarily.  
To prevent this. take appropriate measures, e.g. set the carrier frequency to a lower value, use earth leakage circuit breaker designed for suppression of harmonics and surges, and use the electronic overcurrent protection built in the inverter.

## ATEX DIRECTIVE

- This product complies with ATEX Category 2D, zone 21 requirements.
- A static hazard may exist – Do not clean non-metallic parts with a dry cloth.
- Ensure torque setting on fixings highlighted below conform to the values stated on page 5 “Technical Specification”.
- Do not open any electrical enclosures when product is energized or when an explosive dust atmosphere is present.
- Regular inspection of plastic and gasket materials should be made to ensure no wear or damaged has occurred that may affect the ingress integrity of the system.
- The power supply/module enclosure can in some cases accommodate additional glands that can be fitted by the end user. If new glands or blanking plugs are fitted by the end user they must ensure that the fitting are of metal construction and that the ingress integrity of the enclosure is maintained. (Must be sealed to IP6X or better).



## ATEX system label

|   |  |                |
|---|--|----------------|
| <b>Safeline</b><br>METAL DETECTION  | Montford St.<br>Salford<br>England             |                |
|   | System Identifier                              |                |
|   | Year of Manufacture                            |                |
|   | Model  |                |
| System Rating   | IP Rating                                      |                |
| Voltage/Spannung/<br>Tension/Voltaje  | 100 110 120 220 230 240<br>380 400 415 440 Vac |                |
| Phase/Phase/Phase/ Fase<br>Frequency/Frequenz<br>Fréquence/Frecuencia   | 1ø 3ø<br>50 60 Hz                              |                |
| Power/Leistung/<br>Puissance/Poder/   | 100 300 600 1K 3K<br>5K 10K Watts (Max.)       |                |
| Max surface temp/ Maximale<br>oberflächentemperatur/ Température<br>maximum de surface/ Temp. superficial max.            |  | 79 °C          |
| Ambient temperature range/<br>Umgebungstemperaturbereich von/ Gamme<br>de température ambiante/ Límites de<br>temperatura |  | -10°C to +40°C |
| 0539  II 2 D c DEMKO 02ATEX134042   |  |                |

## ATEX Static warning label

|  |   |  |
|--|---|--|
|  | <b>CAUTION</b><br>Refer to manual for<br>connection details | <b>ACHTUNG</b><br>Vor inbetriebnahme<br>bedienanleitung beachten |
|  | <b>ATTENTION</b><br>Voir le manuel<br>avant tout cablage    | <b>CAUCION</b><br>Le refiere a manual<br>por conecction detalla  |

A static hazard may exist - do not clean non -metallic parts with a dry cloth

Es gibt gegebenenfalls Probleme mit statischen Aufladungen - Bitte nicht-metallische Teile nicht mit trockenen Tüchern o.ä. reinigen

Un risque d'électricité statique peut exister - Ne pas nettoyer les parties non méalliques avec un chiffon sec

Pueden generarse cargas estáticas. No limpiar las partes no metálicas con un paño seco

## ATEX Enclosure warning label

|  |  |   |
|--|--|---|
|  | <b>Warning</b><br>Do not open when<br>energised or when an<br>explosive dust<br>atmosphere is present                              | <b>Achtung</b><br>Nicht öffnen bei<br>eingeschalteter anlage<br>oder in explosiver<br>atmosphäre  |
|  | <b>Precaucion</b><br>No abrir bajo tensión eléctrica<br>conectada, o cuando una<br>atmosfera de polvo deflagrante<br>esté presente | <b>Attention</b><br>Ne pas ouvrir sous<br>tension ou en présence<br>d'une atmosphère<br>explosive |